

Reactor® 2 Hydraulic Proportioning Systems

334946H
EN

Hydraulic, heated, plural component proportioner for spraying polyurethane foam and polyurea coatings.
Not for outdoor use. For professional use only.
Not approved for use in explosive atmospheres or hazardous (classified) locations.



Important Safety Instructions

Read all warnings and instructions in this manual. Save these instructions.

For model information, see page 10.

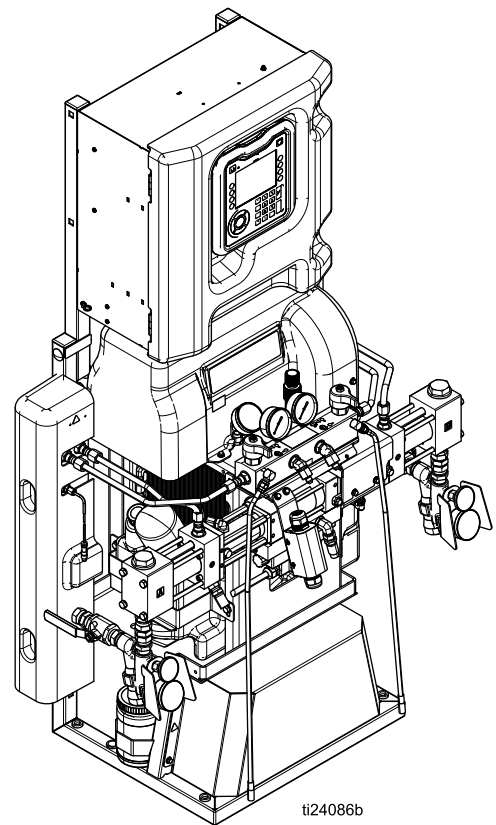

















Contents







Warnings	3	Calibration Procedure.....	65
Important Isocyanate Information.....	7	Repair Circuit Breaker Module	66
Related Manuals	9	Transformer Primary Check.....	67
Accessories.....	9	Transformer Secondary Check	67
Models.....	10	Replace Transformer.....	68
Troubleshooting.....	16	Replace Power Supply	68
Troubleshoot Errors	16	Replace Surge Protector	69
Hydraulic Drive System	36	Replace Temperature Control Module	
Proportioning System.....	38	(TCM).....	69
Pressure/Material Imbalance	39	Replace HCM	70
Pumps Do Not Reverse Direction.....	40	Replace ADM	70
Hose Heat System	42	Software Update Procedure.....	70
Primary Heater	45	Update ADM Software.....	71
Flow Meter	46	Parts.....	72
Pressure Relief Procedure	47	Elite Proportioners	72
Shutdown.....	48	Proportioner Parts.....	73
Flushing.....	49	Proportioner Assembly Parts	86
Repair.....	50	Hydraulic Cylinder Parts, 17G499	88
Before Beginning Repair.....	50	Electrical Enclosure.....	93
Pumpline Disassembly	50	System Din Rail and Harness Module	
Flush Inlet Strainer Screen	51	Kits.....	95
Repair Proportioning Pumps.....	52	H-30, H-XP2 Power Supply and Terminal	
Clean Flow Meter.....	53	Block Module	96
Change Pump Lubricant.....	54	H-30, H-XP2 System Circuit Breaker	
Change Hydraulic Fluid and Filter	54	Module.....	96
Replace Electric Motor	56	Inlet Sensor Kit	98
Replace Belt.....	58	H-40, H-50, H-XP3 Power Supply and	
Replace Fluid Inlet Sensor.....	58	Terminal Block Module.....	101
Replace Flow Meter	59	H-40, H-50, H-XP3 System Circuit Breaker	
Replace Pressure Transducers.....	59	Module.....	101
Repair Primary Heater.....	60	Electrical Schematics.....	102
Repair Heater Overtemperature		Hydraulic Reactor 2 Repair Spare Parts	
Switch.....	60	Reference.....	107
Replace RTD.....	61	Technical Specifications.....	108
Repair Heated Hose.....	62	California Proposition 65	109
Repair Fluid Temperature Sensor		Graco Extended Warranty	110
(FTS).....	64		







Warnings

The following warnings are for the setup, use, grounding, maintenance, and repair of this equipment. The exclamation point symbol alerts you to a general warning and the hazard symbols refer to procedure-specific risks. When these symbols appear in the body of this manual or on warning labels, refer back to these Warnings. Product-specific hazard symbols and warnings not covered in this section may appear throughout the body of this manual where applicable.

 DANGER	
 	<p>SEVERE ELECTRIC SHOCK HAZARD</p> <p>This equipment can be powered by more than 240 V. Contact with this voltage will cause death or serious injury.</p> <ul style="list-style-type: none"> • Turn off and disconnect power at main switch before disconnecting any cables and before servicing equipment. • This equipment must be grounded. Connect only to grounded power source. • All electrical wiring must be done by a qualified electrician and comply with all local codes and regulations.
 WARNING	
	<p>TOXIC FLUID OR FUMES</p> <p>Toxic fluids or fumes can cause serious injury or death if splashed in the eyes or on skin, inhaled or swallowed.</p> <ul style="list-style-type: none"> • Read Safety Data Sheet (SDS) for handling instructions and to know the specific hazards of the fluids you are using, including the effects of long-term exposure. • When spraying, servicing equipment, or when in the work area, always keep work area well ventilated and always wear appropriate personal protective equipment. See Personal Protective Equipment warnings in this manual. • Store hazardous fluid in approved containers, and dispose of it according to applicable guidelines.
	<p>PERSONAL PROTECTIVE EQUIPMENT</p> <p>Always wear appropriate personal protective equipment and cover all skin when spraying, servicing equipment, or when in the work area. Protective equipment helps prevent serious injury, including long-term exposure; inhalation of toxic fumes, mists or vapors; allergic reaction; burns; eye injury and hearing loss. This protective equipment includes but is not limited to:</p> <ul style="list-style-type: none"> • A properly fitting respirator, which may include a supplied-air respirator, chemically impermeable gloves, protective clothing and foot coverings as recommended by the fluid manufacturer and local regulatory authority. • Protective eyewear and hearing protection.

 <h1 style="margin: 0;">WARNING</h1>	
    	<p>SKIN INJECTION HAZARD</p> <p>High-pressure fluid from dispensing device, hose leaks, or ruptured components will pierce skin. This may look like just a cut, but it is a serious injury that can result in amputation. Get immediate surgical treatment.</p> <ul style="list-style-type: none"> • Engage trigger lock when not spraying. • Do not point dispensing device at anyone or at any part of the body. • Do not put your hand over the fluid outlet. • Do not stop or deflect leaks with your hand, body, glove, or rag. • Follow the Pressure Relief Procedure when you stop dispensing and before cleaning, checking, or servicing equipment. • Tighten all fluid connections before operating the equipment. • Check hoses and couplings daily. Replace worn or damaged parts immediately.
   	<p>FIRE AND EXPLOSION HAZARD</p> <p>Flammable fumes, such as solvent and paint fumes, in work area can ignite or explode. Paint or solvent flowing through the equipment can cause static sparking. To help prevent fire and explosion:</p> <ul style="list-style-type: none"> • Use equipment only in well ventilated area. • Eliminate all ignition sources; such as pilot lights, cigarettes, portable electric lamps, and plastic drop cloths (potential static sparking). • Ground all equipment in the work area. See Grounding instructions. • Never spray or flush solvent at high pressure. • Keep work area free of debris, including solvent, rags and gasoline. • Do not plug or unplug power cords, or turn power or light switches on or off when flammable fumes are present. • Use only grounded hoses. • Hold gun firmly to side of grounded pail when triggering into pail. Do not use pail liners unless they are anti-static or conductive. • Stop operation immediately if static sparking occurs or you feel a shock. Do not use equipment until you identify and correct the problem. • Keep a working fire extinguisher in the work area.

 <h1 style="margin: 0;">WARNING</h1>	
  	<p>THERMAL EXPANSION HAZARD</p> <p>Fluids subjected to heat in confined spaces, including hoses, can create a rapid rise in pressure due to the thermal expansion. Over-pressurization can result in equipment rupture and serious injury.</p> <ul style="list-style-type: none"> • Open a valve to relieve the fluid expansion during heating. • Replace hoses proactively at regular intervals based on your operating conditions.
	<p>PRESSURIZED ALUMINUM PARTS HAZARD</p> <p>Use of fluids that are incompatible with aluminum in pressurized equipment can cause serious chemical reaction and equipment rupture. Failure to follow this warning can result in death, serious injury, or property damage.</p> <ul style="list-style-type: none"> • Do not use 1,1,1-trichloroethane, methylene chloride, other halogenated hydrocarbon solvents or fluids containing such solvents. • Do not use chlorine bleach. • Many other fluids may contain chemicals that can react with aluminum. Contact your material supplier for compatibility.
 	<p>PLASTIC PARTS CLEANING SOLVENT HAZARD</p> <p>Many solvents can degrade plastic parts and cause them to fail, which could cause serious injury or property damage.</p> <ul style="list-style-type: none"> • Use only compatible water-based solvents to clean plastic structural or pressure-containing parts. • See Technical Specifications in this and all other equipment instruction manuals. Read fluid and solvent manufacturer's MSDSs and recommendations.

 <h1 style="margin: 0;">WARNING</h1>	
 	<p>EQUIPMENT MISUSE HAZARD</p> <p>Misuse can cause death or serious injury.</p> <ul style="list-style-type: none"> • Do not operate the unit when fatigued or under the influence of drugs or alcohol. • Do not exceed the maximum working pressure or temperature rating of the lowest rated system component. See Technical Specifications in all equipment manuals. • Use fluids and solvents that are compatible with equipment wetted parts. See Technical Data in all equipment manuals. Read fluid and solvent manufacturer's warnings. For complete information about your material, request MSDS from distributor or retailer. • Do not leave the work area while equipment is energized or under pressure. • Turn off all equipment and follow the Pressure Relief Procedure when equipment is not in use. • Check equipment daily. Repair or replace worn or damaged parts immediately with genuine manufacturer's replacement parts only. • Do not alter or modify equipment. Alterations or modifications may void agency approvals and create safety hazards. • Make sure all equipment is rated and approved for the environment in which you are using it. • Use equipment only for its intended purpose. Call your distributor for information. • Route hoses and cables away from traffic areas, sharp edges, moving parts, and hot surfaces. • Do not kink or over bend hoses or use hoses to pull equipment. • Keep children and animals away from work area. • Comply with all applicable safety regulations.
 	<p>MOVING PARTS HAZARD</p> <p>Moving parts can pinch, cut or amputate fingers and other body parts.</p> <ul style="list-style-type: none"> • Keep clear of moving parts. • Do not operate equipment with protective guards or covers removed. • Equipment can start without warning. Before checking, moving, or servicing equipment, follow the Pressure Relief Procedure and disconnect all power sources.
	<p>BURN HAZARD</p> <p>Equipment surfaces and fluid that is heated can become very hot during operation. To avoid severe burns:</p> <ul style="list-style-type: none"> • Do not touch hot fluid or equipment.

Important Isocyanate Information

Isocyanates (ISO) are catalysts used in two component materials.

Isocyanate Conditions

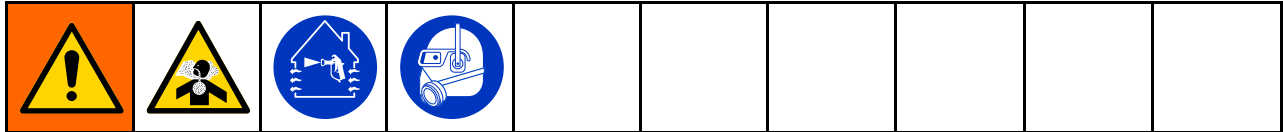



Spraying or dispensing fluids that contain isocyanates creates potentially harmful mists, vapors, and atomized particulates.



- Read and understand the fluid manufacturer’s warnings and Safety Data Sheet (SDS) to know specific hazards and precautions related to isocyanates.
- Use of isocyanates involves potentially hazardous procedures. Do not spray with this equipment unless you are trained, qualified, and have read and understood the information in this manual and in the fluid manufacturer’s application instructions and SDS.
- Use of incorrectly maintained or mis-adjusted equipment may result in improperly cured material, which could cause off gassing and offensive odors. Equipment must be carefully maintained and adjusted according to instructions in the manual.
- To prevent inhalation of isocyanate mists, vapors and atomized particulates, everyone in the work area must wear appropriate respiratory protection. Always wear a properly fitting respirator, which may include a supplied-air respirator. Ventilate the work area according to instructions in the fluid manufacturer’s SDS.
- Avoid all skin contact with isocyanates. Everyone in the work area must wear chemically impermeable gloves, protective clothing and foot coverings as recommended by the fluid manufacturer and local regulatory authority. Follow all fluid manufacturer recommendations, including those regarding handling of contaminated clothing. After spraying, wash hands and face before eating or drinking.
- Hazard from exposure to isocyanates continues after spraying. Anyone without appropriate personal protective equipment must stay out of the work area during application and after application for the time period specified by the fluid manufacturer. Generally this time period is at least 24 hours.
- Warn others who may enter work area of hazard from exposure to isocyanates. Follow the recommendations of the fluid manufacturer and local regulatory authority. Posting a placard such as the following outside the work area is recommended:



Material Self-Ignition

				
Some materials may become self-igniting if applied too thick. Read material manufacturer's warnings and SDS.				

Keep Components A and B Separate

				
Cross-contamination can result in cured material in fluid lines which could cause serious injury or damage to equipment. To prevent cross-contamination:				
<ul style="list-style-type: none">• Never interchange component A and component B wetted parts.• Never use solvent on one side if it has been contaminated from the other side.				

Changing Materials

NOTICE				
Changing the material types used in your equipment requires special attention to avoid equipment damage and downtime.				
<ul style="list-style-type: none">• When changing materials, flush the equipment multiple times to ensure it is thoroughly clean.• Always clean the fluid inlet strainers after flushing.• Check with your material manufacturer for chemical compatibility.• When changing between epoxies and urethanes or polyureas, disassemble and clean all fluid components and change hoses. Epoxies often have amines on the B (hardener) side. Polyureas often have amines on the B (resin) side.				

Moisture Sensitivity of Isocyanates

Exposure to moisture (such as humidity) will cause ISO to partially cure, forming small, hard, abrasive crystals that become suspended in the fluid. Eventually a film will form on the surface and the ISO will begin to gel, increasing in viscosity.

NOTICE				
Partially cured ISO will reduce performance and the life of all wetted parts.				
<ul style="list-style-type: none">• Always use a sealed container with a desiccant dryer in the vent, or a nitrogen atmosphere. Never store ISO in an open container.• Keep the ISO pump wet cup or reservoir (if installed) filled with appropriate lubricant. The lubricant creates a barrier between the ISO and the atmosphere.• Use only moisture-proof hoses compatible with ISO.• Never use reclaimed solvents, which may contain moisture. Always keep solvent containers closed when not in use.• Always lubricate threaded parts with an appropriate lubricant when reassembling.				

NOTE: The amount of film formation and rate of crystallization varies depending on the blend of ISO, the humidity, and the temperature.

Foam Resins with 245 fa Blowing Agents

Some foam blowing agents will froth at temperatures above 90°F (33°C) when not under pressure, especially if agitated. To reduce frothing, minimize preheating in a circulation system.

Related Manuals

Component Manuals in English:

Manuals are available at www.graco.com.



System Manuals	
334945	Reactor 2 Proportioner, Operation
Displacement Pump Manual	
3A3085	Pump, Repair-Parts
Feed System Manuals	
309852	Circulation and Return Tube Kit, Instructions-Parts
309815	Feed Pump Kits, Instructions-Parts
309827	Feed Pump Air Supply Kit, Instructions-Parts
Spray Gun Manuals	
309550	Fusion AP Gun
312666	Fusion CS Gun
313213	Probler P2 Gun
Accessory Manuals	
309572	Heated Hose, Instructions-Parts
3A3009	Inlet Sensor Kit, Instructions-Parts
3A1907	Remote Display Module Kit, Instructions-Parts
332735	Air Manifold Kit, Instructions-Parts
3A3010	Caster Kit, Instructions-Parts
333276	Graco InSite™ Kit, Instructions-Parts
3A3084	Elite Kit, Instructions-Part

Accessories

Kit Number	Description
24U315	Air Manifold (4 outlets)
17G340	Caster Kit
17F837	Inlet Sensor Kit
16X521	Graco InSite Extension cable 24.6 ft (7.5 m)
24N449	50 ft (15 m) CAN cable (for remote display module)
24K207	Fluid Temperature Sensor (FTS) with RTD
24U174	Remote Display Module Kit
15V551	ADM Protective Covers (10 pack)
15M483	Remote Display Module Protective Covers (10 pack)
24M174	Drum Level Sticks
121006	150 ft (45 m) CAN cable (for remote display module)
24N365	RTD Test Cables (to aide resistance measurements)
17F838	Elite Kit
24N748	Ratio Monitoring
*979200	Integrated Power Station, Tier 4 Final, no air
*979201	Integrated Power Station, Tier 4 Final, 20 cfm
*979202	Integrated Power Station, Tier 4 Final, 35 cfm

Models

Reactor 2 H-30 and H-30 Elite

Model	H-30 Model						H-30 Elite Model					
	10 kW			15 kW			10 kW			15 kW		
Proportioner ★	17H031			17H032			17H131			17H132		
Maximum Fluid Working Pressure psi (MPa, bar)	2000 (14, 140)			2000 (14, 140)			2000 (14, 140)			2000 (14, 140)		
Approximate Output per Cycle (A+B) gal. (liter)	0.074 (0.28)			0.074 (0.28)			0.074 (0.28)			0.074 (0.28)		
Max Flow Rate lb/min (kg/min)	28 (12.7)			28 (12.7)			28 (12.7)			28 (12.7)		
Total System Load † (Watts)	17,960			23,260			17,960			23,260		
Configurable Voltage Phase (VAC, 50/60 Hz)	200-240 1Ø	200-240 3ØΔ	350-415 3ØY	200-240 1Ø	200-240 3ØΔ	350-415 3ØY	200-240 1Ø	200-240 3ØΔ	350-415 3ØY	200-240 1Ø	200-240 3ØΔ	350-415 3ØY
Full Load Peak Current*	79	46	35	100	59	35	79	46	35	100	59	35
Approvals	 Intertek 9902471 Conforms to ANSI/UL Std. 499 Certified to CAN/CSA Std. C22.2 No. 88 											

Fusion® AP Package ✖ <i>(Gun Part)</i>	APH031 <i>(246102)</i>	AHH031 <i>(246102)</i>	APH032 <i>(246102)</i>	AHH032 <i>(246102)</i>	APH131 <i>(246102)</i>	AHH131 <i>(246102)</i>	APH132 <i>(246102)</i>	AHH132 <i>(246102)</i>
Fusion® CS Package ✖ <i>(Gun Part)</i>	CSH031 <i>(CS02RD)</i>	CHH031 <i>(CS02RD)</i>	CSH032 <i>(CS02RD)</i>	CHH032 <i>(CS02RD)</i>	CSH131 <i>(CS02RD)</i>	CHH131 <i>(CS02RD)</i>	CSH132 <i>(CS02RD)</i>	CHH132 <i>(CS02RD)</i>
Probler P2 Package ✖ <i>(Gun Part)</i>	P2H031 <i>(GCP2R2)</i>	PHH031 <i>(GCP2R2)</i>	P2H032 <i>(GCP2R2)</i>	PHH032 <i>(GCP2R2)</i>	P2H131 <i>(GCP2R2)</i>	PHH131 <i>(GCP2R2)</i>	P2H132 <i>(GCP2R2)</i>	PHH132 <i>(GCP2R2)</i>
Heated Hose 50 ft (15 m) 24K240 (scuff guard) 24Y240 (Xtreme-wrap)	24K240 Qty: 1	24K240 Qty: 5	24K240 Qty: 1	24K240 Qty: 5	24Y240 Qty: 1	24Y240 Qty: 5	24Y240 Qty: 1	24Y240 Qty: 5
Heated Whip Hose 10 ft (3 m)	246050		246050		246050		246050	
Ratio Monitoring					✓		✓	
Fluid Inlet Sensors (2)					✓		✓	

* Full load amps with all devices operating at maximum capabilities. Fuse requirements at various flow rates and mix chamber sizes may be less.

† Total system watts used by system, based on maximum heated hose length for each unit.



- H-30 series: 310 ft (94.5 m) maximum heated hose length, including whip hose.

★ Intertek approvals apply to proportioners without hoses.

✖ Packages include gun, heated hose, and whip hose. Elite packages also include Ratio Monitoring and fluid inlet sensors. All Elite hose and gun system packages include Xtreme-Wrap™ 50 ft (15 m) heated hose. For part numbers, see [Accessories, page 9](#).

Voltage Configurations Key	
Ø	PHASE
Δ	DELTA
Y	WYE

Reactor 2 H-40 and H-40 Elite, 200–240V

Model	H-40 Model		H-40 Elite Model	
	15 kW	20 kW	15 kW	20 kW
Proportioner ★	17H043	17H044	17H143	17H144
Maximum Fluid Working Pressure psi (MPa, bar)	2000 (14, 140)	2000 (14, 140)	2000 (14, 140)	2000 (14, 140)
Approximate Output per Cycle (A+B) gal. (liter)	0.063 (0.24)	0.063 (0.24)	0.063 (0.24)	0.063 (0.24)
Max Flow Rate lb/min (kg/min)	45 (20)	45 (20)	45 (20)	45 (20)
Total System Load † (Watts)	26,600	31,700	26,600	31,700
Voltage Phase (VAC 50/60 Hz)	200–240 3ØΔ	200–240 3ØΔ	200–240 3ØΔ	200–240 3ØΔ
Full Load Peak Current*	71	95	71	95
Approvals	 Intertek 9902471 Conforms to ANSI/UL Std. 499 Certified to CAN/CSA Std. C22.2 No. 88 			

Fusion® AP Package ✖ <i>(Gun Part)</i>	APH043 <i>(246102)</i>	AHH043 <i>(246102)</i>	APH044 <i>(246102)</i>	AHH044 <i>(246102)</i>	APH143 <i>(246102)</i>	AHH143 <i>(246102)</i>	APH144 <i>(246102)</i>	AHH144 <i>(246102)</i>
Fusion® CS Package ✖ <i>(Gun Part)</i>	CSH043 <i>(CS02RD)</i>	CHH043 <i>(CS02RD)</i>	CSH044 <i>(CS02RD)</i>	CHH044 <i>(CS02RD)</i>	CSH143 <i>(CS02RD)</i>	CHH143 <i>(CS02RD)</i>	CSH144 <i>(CS02RD)</i>	CHH144 <i>(CS02RD)</i>
Probler P2 Package ✖ <i>(Gun Part)</i>	P2H043 <i>(GCP2R2)</i>	PHH043 <i>(GCP2R2)</i>	P2H044 <i>(GCP2R2)</i>	PHH044 <i>(GCP2R2)</i>	P2H143 <i>(GCP2R2)</i>	PHH143 <i>(GCP2R2)</i>	P2H144 <i>(GCP2R2)</i>	PHH144 <i>(GCP2R2)</i>
Heated Hose 50 ft (15 m) 24K240 (scuff guard) 24Y240 (Xtreme-wrap)	24K240	24K240	24K240	24K240	24Y240	24Y240	24Y240	24Y240
	Qty: 1	Qty: 6	Qty: 1	Qty: 6	Qty: 1	Qty: 6	Qty: 1	Qty: 6
Heated Whip Hose 10 ft (3 m)	246050		246050		246050		246050	
Ratio Monitoring					✓		✓	
Fluid Inlet Sensors (2)					✓		✓	

* Full load amps with all devices operating at maximum capabilities. Fuse requirements at various flow rates and mix chamber sizes may be less.

† Total system watts used by system, based on maximum heated hose length for each unit.

- H-40 series: 410 ft (125 m) maximum heated hose length, including whip hose.

★ Intertek approvals apply to proportioners without hoses.

✖ Packages include gun, heated hose, and whip hose. Elite packages also include Ratio Monitoring and fluid inlet sensors. All Elite hose and gun system packages include Xtreme-Wrap™ 50 ft (15 m) heated hose. For part numbers, see [Accessories, page 9](#).

Voltage Configurations Key	
Ø	PHASE
Δ	DELTA
Y	WYE

Reactor 2 H-40 and H-40 Elite, 350–415V (Continued)

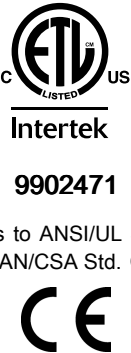
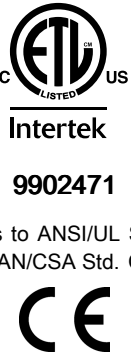
Model	H-40 Model			H-40 Elite Model	
	15 kW	20 kW	15 kW	15 kW	20 kW
Proportioner ★	17H045	17H046	25R549	17H145	17H146
Maximum Fluid Working Pressure psi (MPa, bar)	2000 (14, 140)	2000 (14, 140)	2000 (14, 140)	2000 (14, 140)	2000 (14, 140)
Approximate Output per Cycle (A+B) gal. (liter)	0.063 (0.24)	0.063 (0.24)	0.0525 (0.20)	0.063 (0.24)	0.063 (0.24)
Max Flow Rate lb/min (kg/min)	45 (20)	45 (20)	1.875 (7.1)	45 (20)	45 (20)
Total System Load † (Watts)	26,600	31,700	31700	26,600	31,700
Voltage Phase (VAC 50/60 Hz)	350–415 3ØY	350–415 3ØY	350–415 3ØY	350–415 3ØY	350–415 3ØY
Full Load Peak Current*	41	52	52	41	52
Approvals	 <p>Conforms to ANSI/UL Std. 499 Certified to CAN/CSA Std. C22.2 No. 88</p>			 <p>Conforms to ANSI/UL Std. 499 Certified to CAN/CSA Std. C22.2 No. 88</p>	

Fusion® AP Package ✖ (Gun Part)	APH045 (246102)	AHH045 (246102)	APH046 (246102)	AHH046 (246102)	APH145 (246102)	AHH145 (246102)	APH146 (246102)	AHH146 (246102)
Fusion® CS Package ✖ (Gun Part)	CSH045 (CS02RD)	CHH045 (CS02RD)	CSH046 (CS02RD)	CHH046 (CS02RD)	CSH145 (CS02RD)	CHH145 (CS02RD)	CSH146 (CS02RD)	CHH146 (CS02RD)
Probler P2 Package ✖ (Gun Part)	P2H045 (GCP2R2)	PHH045 (GCP2R2)	P2H046 (GCP2R2)	PHH046 (GCP2R2)	P2H145 (GCP2R2)	PHH145 (GCP2R2)	P2H146 (GCP2R2)	PHH146 (GCP2R2)
Heated Hose 50 ft (15 m)	24K240	24K240	24K240	24K240	24Y240	24Y240	24Y240	24Y240
24K240 (scuff guard) 24Y240 (Xtreme-wrap)	Qty: 1	Qty: 6	Qty: 1	Qty: 6	Qty: 1	Qty: 6	Qty: 1	Qty: 6
Heated Whip Hose 10 ft (3 m)	246050		246050		246050		246050	
Ratio Monitoring						✓		✓
Fluid Inlet Sensors (2)						✓		✓

* Full load amps with all devices operating at maximum capabilities. Fuse requirements at various flow rates and mix chamber sizes may be less.

† Total system watts used by system, based on maximum heated hose length for each unit.



- H-40 series: 410 ft (125 m) maximum heated hose length, including whip hose.

★ Intertek approvals apply to proportioners without hoses.

✖ Packages include gun, heated hose, and whip hose. Elite packages also include Ratio Monitoring and fluid inlet sensors. All Elite hose and gun system packages include Xtreme-Wrap™ 50 ft (15 m) heated hose. For part numbers, see [Accessories, page 9](#).

Voltage Configurations Key	
Ø	PHASE
Δ	DELTA
Y	WYE

Reactor 2 H-50 and H-50 Elite

Model	H-50 Model		H-50 Elite Model	
	20 kW	20 kW	20 kW	20 kW
Proportioner ★	17H053	17H056	17H153	17H156
Maximum Fluid Working Pressure psi (MPa, bar)	2000 (14, 140)	2000 (14, 140)	2000 (14, 140)	2000 (14, 140)
Approximate Output per Cycle (A+B) gal. (liter)	0.074 (0.28)	0.074 (0.28)	0.074 (0.28)	0.074 (0.28)
Max Flow Rate lb/min (kg/min)	52 (24)	52 (24)	52 (24)	52 (24)
Total System Load † (Watts)	31,700	31,700	31,700	31,700
Voltage Phase (VAC, 50/60 Hz)	200–240 3ØΔ	350–415 3ØY	200–240 3ØΔ	350–415 3ØY
Full Load Peak Current*	95	52	95	52
Approvals	 Intertek 9902471 Conforms to ANSI/UL Std. 499 Certified to CAN/CSA Std. C22.2 No. 88 			

Fusion® AP Package ✖ (Gun Part)	APH053 (246102)	AHH053 (246102)	APH056 (246102)	AHH056 (246102)	APH153 (246102)	AHH153 (246102)	APH156 (246102)	AHH156 (246102)
Fusion® CS Package ✖ (Gun Part)	CSH053 (CS02RD)	CHH053 (CS02RD)	CSH056 (CS02RD)	CHH056 (CS02RD)	CSH153 (CS02RD)	CHH153 (CS02RD)	CSH156 (CS02RD)	CHH156 (CS02RD)
Probler P2 Package ✖ (Gun Part)	P2H053 (GCP2 R2)	PHH053 (GCP2 R2)	P2H056 (GCP2 R2)	PHH056 (GCP2R2)	P2H153 (GCP2 R2)	PHH153 (GCP2R2)	P2H156 (GCP2 R2)	PHH156 (GCP2 R2)
Heated Hose 50 ft (15 m) 24K240 (scuff guard) 24Y240 (Xtreme-wrap)	24K240	24K240	24K240	24K240	24Y240	24Y240	24Y240	24Y240
	Qty: 1	Qty: 6	Qty: 1	Qty: 6	Qty: 1	Qty: 6	Qty: 1	Qty: 6
Heated Whip Hose 10 ft (3 m)	246050		246050		246050		246050	
Ratio Monitoring					✓		✓	
Fluid Inlet Sensors (2)					✓		✓	

* Full load amps with all devices operating at maximum capabilities. Fuse requirements at various flow rates and mix chamber sizes may be less.

† Total system watts used by system, based on maximum heated hose length for each unit.

- H-50 series: 410 ft (125 m) maximum heated hose length, including whip hose.



★ Intertek approvals apply to proportioners without hoses.

✖ Packages include gun, heated hose, and whip hose. Elite packages also include Ratio Monitoring and fluid inlet sensors. All Elite hose and gun system packages include Xtreme-Wrap™ 50 ft (15 m) heated hose. For part numbers, see [Accessories, page 9](#).

Voltage Configurations Key

Ø	PHASE
Δ	DELTA
Y	WYE

Reactor 2 H-XP2 and H-XP2 Elite

Model	H-XP2 Model			H-XP2 Elite Model		
	15 kW			15kW		
Proportioner ★	17H062			17H162		
Maximum Fluid Working Pressure psi (MPa, bar)	3500 (24.1, 241)			3500 (24.1, 241)		
Approximate Output per Cycle (A+B) gal. (liter)	0.042 (0.16)			0.042 (0.16)		
Max Flow Rate gpm (lpm)	1.5 (5.7)			1.5 (5.7)		
Total System Load † (Watts)	23,260			23,260		
Voltage Phase (VAC, 50/60 Hz)	200–240 1Ø	200–240 3ØΔ	350–415 3ØY	200–240 1Ø	200–240 3ØΔ	350–415 3ØY
Full Load Peak Current*	100	59	35	100	59	35
Approvals	 9902471 Conforms to ANSI/UL Std. 499 Certified to CAN/CSA Std. C22.2 No. 88 					

Fusion® AP Package ✖ <i>(Gun Part)</i>	APH062 <i>(246101)</i>	AHH062 <i>(246101)</i>	APH162 <i>(246101)</i>	AHH162 <i>(246101)</i>
Probler P2 Package ✖ <i>(Gun Part)</i>	P2H062 <i>(GCP2R1)</i>	PHH062 <i>(GCP2R1)</i>	P2H162 <i>(GCP2R1)</i>	PHH162 <i>(GCP2R1)</i>
Heated Hose 50 ft (15 m)	24K241	24K241	24Y241	24K241
	Qty. 1	Qty. 5	Qty. 1	Qty. 5
Heated Whip Hose 10 ft (3 m)	246055		246055	
Fluid Inlet Sensors (2)			✓	

* Full load amps with all devices operating at maximum capabilities. Fuse requirements at various flow rates and mix chamber sizes may be less.

† Total system watts used by system, based on maximum heated hose length for each unit.



- H-XP2 series: 310 ft (94.5 m) maximum heated hose length, including whip hose.

★ Intertek approvals apply to proportioners without hoses.

✖ Packages include gun, heated hose, and whip hose. Elite packages also include fluid inlet sensors. All Elite hose and gun system packages include Xtreme-Wrap™ 50 ft (15 m) heated hose. For part numbers, see [Accessories, page 9](#).

Voltage Configurations Key	
Ø	PHASE
Δ	DELTA
Y	WYE

Reactor 2 H-XP3 and H-XP3 Elite

Model	H-XP3 Model		H-XP3 Elite Model	
	20 kW	20 kW	20 kW	20 kW
Proportioner ★	17H074	17H076	17H174	17H176
Maximum Fluid Working Pressure psi (MPa, bar)	3500 (24.1, 241)	3500 (24.1, 241)	3500 (24.1, 241)	3500 (24.1, 241)
Approximate Output per Cycle (A+B) gal. (liter)	0.042 (0.16)	0.042 (0.16)	0.042 (0.16)	0.042 (0.16)
Max Flow Rate gpm (lpm)	2.8 (10.6)	2.8 (10.6)	2.8 (10.6)	2.8 (10.6)
Total System Load † (Watts)	31,700	31,700	31,700	31,700
Voltage Phase (VAC 50/60 Hz)	200–240 3ØΔ	350–415 3ØY	200–240 3ØΔ	350–415 3ØY
Full Load Peak Current*	95	52	95	52
Approvals	 Intertek 9902471 Conforms to ANSI/UL Std. 499 Certified to CAN/CSA Std. C22.2 No. 88 			

Fusion® AP Package ✖ (Gun Part)	APH074 (246102)	AHH074 (246102)	APH076 (246102)	AHH076 (246102)	APH174 (246102)	AHH174 (246102)	APH176 (246102)	AHH176 (246102)
Probler P2 Package ✖ (Gun Part)	P2H074 (GCP2 R2)	PHH074 (GCP2 R2)	P2H076 (GCP2 R2)	PHH076 (GCP2R2)	P2H174 (GCP2 R2)	PHH174 (GCP2R2)	P2H176 (GCP2 R2)	PHH176 (GCP2 R2)
Heated Hose 50 ft (15 m) 24K240 (scuff guard) 24Y240 (Xtreme-wrap)	24K241	24K241	24K241	24K241	24Y241	24Y241	24Y241	24Y241
	Qty: 1	Qty: 6	Qty: 1	Qty: 6	Qty: 1	Qty: 6	Qty: 1	Qty: 6
Heated Whip Hose 10 ft (3 m)	246055		246055		246055		246055	
Fluid Inlet Sensors (2)					✓		✓	

* Full load amps with all devices operating at maximum capabilities. Fuse requirements at various flow rates and mix chamber sizes may be less.

† Total system watts used by system, based on maximum heated hose length for each unit.

- H-XP3 series: 410 ft (125 m) maximum heated hose length, including whip hose.

★ Intertek approvals apply to proportioners without hoses.

✖ Packages include gun, heated hose, and whip hose. Elite packages also include Ratio Monitoring and fluid inlet sensors. All Elite hose and gun system packages include Xtreme-Wrap™ 50 ft (15 m) heated hose. For part numbers, see [Accessories, page 9](#).

Voltage Configurations Key

Ø	PHASE
Δ	DELTA
Y	WYE

Troubleshooting

<p>DANGER</p> <p>SEVERE ELECTRIC SHOCK HAZARD</p> <p>This equipment can be powered by more than 240 V. Connect with this voltage will cause death or serious injury.</p> <ul style="list-style-type: none"> • Turn off and disconnect power at main switch before disconnecting any cables and before servicing equipment. • All electrical wiring must be done by a qualified electrician and comply with all local codes and regulations. 				

<p>To avoid injury due to unexpected machine operation initiated by a remote controller, disconnect the cellular module from the system prior to troubleshooting. Refer to your Reactor 2 App manual for instructions.</p>				

Troubleshoot Errors

There are three types of errors that can occur. Errors are indicated on the display as well as by the light tower (optional).

Error	Description
 Alarms	A parameter critical to the process has reached a level requiring the system to stop. The alarm needs to be addressed immediately.
 Deviations	A parameter critical to the process has reached a level requiring attention, but not sufficient enough to stop the system at this time.
 Advisories	A parameter that is not immediately critical to the process. The advisory needs attention to prevent more serious issues in the future.

See [Error Codes](#), for causes and solutions to each error code.

To troubleshoot the error:

1. Press the soft key for help with the active error.

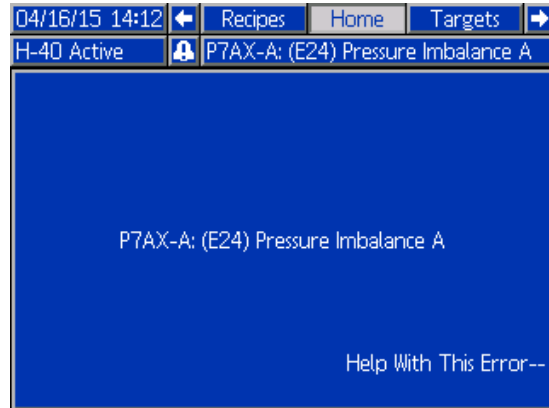

NOTE: Press or to return to the previously displayed screen.







2. The QR code screen will be displayed. Scan the QR code with your smartphone to be sent directly to online troubleshooting for the active error code. Otherwise, manually navigate to <http://help.graco.com> and search for the active error.







3. If no internet connection is available, see [Error Codes](#), for causes and solutions for each error code.

Error Codes

NOTE: When an error occurs be sure to determine the code before resetting it. If you forget which error code occurred, see the Errors screen to view the last 200 errors, with date, time, and description.





Error	Location	Type	Description	Cause	Solution
05CH	ADM/TCM		Hose re-calibration recommended	Hose Resistance Mode is selected and TCM has been replaced without re-calibration.	Re-calibrate the hose. Follow the Calibration Procedure, page 65 .
				Hose Resistance Mode is selected and ADM has been moved to a new system without re-calibration.	Re-calibrate the hose. Follow the Calibration Procedure, page 65 .
A4DA	Heater A		High Current A	Short circuit in heater wiring.	Check wiring for touching wires.
				Bad Heater.	Confirm resistance of heater. Heater resistance should be 18–21 Ω for each heater element, 9–12 Ω combined for 10 kW systems, 6–8 Ω for 15 kW systems, and 4–6 Ω for 20 kW systems. If out of tolerance, replace heater element.
A4DB	Heater B		High Current B	Short circuit in heater wiring.	Check wiring for touching wires.
				Bad Heater.	Confirm resistance of heater. Heater resistance should be 18–21 Ω for each heater element, 9–12 Ω combined for 10 kW systems, 6–8 Ω for 15 kW systems, and 4–6 Ω for 20 kW systems. If out of tolerance, replace heater element.
A4DH	Hose		High Current Hose	Short circuit in hose wiring.	Check continuity of transformer windings. Normal readings are about 0.2Ω on both primary and secondary. If reading is 0Ω replace transformer.
					Check for shorts between the primary winding and the support frame or enclosure.
A7DA	Heater A		Unexpected Current A	Shorted TCM	If error cannot be cleared or regenerates consistently, replace module.
A7DB	Heater B		Unexpected Current B	Shorted TCM	If error cannot be cleared or regenerates consistently, replace module.













Troubleshooting

Error	Location	Type	Description	Cause	Solution
A7DH	Hose		Unexpected Current Hose	Shorted TCM	If error cannot be cleared or regenerates consistently, replace module.
A8DA	Heater A		No Current A	Tripped circuit breaker	Visually check circuit breaker for a tripped condition.
				Loose/broken connection	Check heater wiring for loose wires.
A8DB	Heater B		No Current B	Tripped circuit breaker	Visually check circuit breaker for a tripped condition.
				Loose/broken connection	Check heater wiring for loose wires.
A8DH	Hose		No Current Hose	Tripped circuit breaker	Visually check circuit breaker for a tripped condition.
				Loose/broken connection	Check heater wiring for loose wires.



Error	Location	Type	Description	Cause	Solution
CACM	HCM		HCM Communication Error	Module does not have software	Insert a system token into the ADM module and cycle the power. Wait until the upload is complete before removing the token.
				Dial set to wrong position	Ensure the HCM dial is set to the correct position: <ul style="list-style-type: none"> • H-30 = 0 • H-40 = 1 • H-50 = 2 • H-XP2 = 3 • H-XP3 = 4
				No 24 VDC supply to module	Green light on each module should be lit. If green light is not lit, check to make sure each CAN cable connection is tight. Verify the power supply is outputting 24 VDC. If not, check power supply wiring. If wiring is okay, replace the power supply.
				Loose or broken CAN cable	Check the CAN cables running between GCA modules and tighten if needed. If the problem still persists move each cable around the connector and watch the flashing yellow light on the GCA modules. If the yellow light stops flashing, replace the CAN cable.





Troubleshooting

Error	Location	Type	Description	Cause	Solution
CACT	TCM		TCM Communication Error	Module does not have software	Insert a system token into the ADM module and cycle the power. Wait until the upload is complete before removing the token.
				No 24 VDC supply to module	Green light on each module should be lit. If green light is not lit, check to make sure each CAN cable connection is tight. Verify the power supply is outputting 24 VDC. If not, check power supply wiring. If wiring is okay, replace the power supply.
				Loose or broken CAN cable	Check the CAN cables running between GCA modules and tighten if needed. If the problem still persists move each cable around the connector and watch the flashing yellow light on the GCA modules. If the yellow light stops flashing, replace the CAN cable.
DADX	HCM		Pump Runaway	Flow rate is too large	Mix chamber too large for system selected. Use mix chamber rated for system.
					Ensure the system has chemical and the feed pumps are operating correctly.
					No material in pumps. Verify pumps are supplying chemical. If necessary, replace or refill drums.
					Inlet ball valves are closed. Open ball valves.
F9FA	ADM		Flow Cutback Low Inlet A Pressure	ISO Inlet pressure is too low	Increase ISO feed pump pressure.
				ISO inlet flow is too low	Change to larger ISO feed pump.
F9FB	ADM		Flow Cutback Low Inlet B Pressure	Resin inlet pressure is too low	Increase resin feed pump pressure.
				Resin inlet flow is too low	Change to larger resin feed pump.





Error	Location	Type	Description	Cause	Solution
EVCH	ADM		Hose Manual Mode Enabled	Hose Manual Mode has been enabled in System Setup screen	Install a functioning fluid temperature sensor (FTS) in the hose or run in Hose Resistance Mode with a properly saved calibration factor. Follow the Calibration Procedure, page 65 .
EAUX	ADM		USB Busy	USB drive has been inserted to the ADM	Do not remove USB drive until download/upload is complete.
EVSX	HCM		Standby	System has entered standby	Trigger gun to resume spraying. Turn off standby in setup screens.
EVUX	ADM		USB disabled	USB download/uploads are disabled	Enable USB download/uploads on the Advanced Setup screen before inserting a USB drive.
H2MA	Heater A		Low Frequency A	Line frequency is below 45 Hz	Ensure line frequency of incoming power is between 45 and 65 Hz.
H2MB	Heater B		Low Frequency B	Line frequency is below 45 Hz	Ensure line frequency of incoming power is between 45 and 65 Hz.
H2MH	Hose		Low Frequency Hose	Line frequency is below 45 Hz	Ensure line frequency of incoming power is between 45 and 65 Hz.
H3MA	Heater A		High Frequency A	Line frequency is above 65 Hz	Ensure line frequency of incoming power is between 45 and 65 Hz.
H3MB	Heater B		High Frequency B	Line frequency is above 65 Hz	Ensure line frequency of incoming power is between 45 and 65 Hz.
H3MH	Hose		High Frequency Hose	Line frequency is above 65 Hz	Ensure line frequency of incoming power is between 45 and 65 Hz.
L1AX	ADM		Low Chemical Level A	Low material level	Refill material and update drum level on ADM Maintenance screen. Alarm can be disabled on the System Setup screen.
L1BX	ADM		Low Chemical Level B	Low material level	Refill material and update drum level on ADM Maintenance screen. Alarm can be disabled on the System Setup screen.



Troubleshooting

Error	Location	Type	Description	Cause	Solution
MMUX	USB		Maintenance Due - USB	USB logs have reached a level where data loss will occur if logs are not downloaded.	Insert a USB drive into the ADM and download all logs.
P0AX	HCM		Pressure Imbalance A High	Pressure difference between A and B material is greater than the defined value	Ensure material flow is equally restricted on both material lines.
				Pressure imbalance is defined too low	Ensure that the pressure imbalance value, on the System Setup screen, is at an acceptable maximum pressure to prevent unnecessary alarms and abort dispenses.
				Out of material	Fill the tanks with material.
				Fluid leaking from heater inlet rupture disk	Check if heater and PRESSURE RELIEF/SPRAY valve are plugged. Clear. Replace rupture disk. Do not replace with a pipe plug.
				Feed system defective	Check feed pump and hoses for blockage. Check that feed pumps have correct air pressure.
P0BX	HCM		Pressure Imbalance B High	Pressure difference between A and B material is greater than the defined value	Ensure material flow is equally restricted on both material lines.
				Pressure imbalance is defined too low	Ensure that the pressure imbalance value, on the System Setup screen, is at an acceptable maximum pressure to prevent unnecessary alarms and abort dispenses.
				Out of material	Fill the tanks with material.
				Fluid leaking from heater inlet rupture disk	Check if heater and PRESSURE RELIEF/SPRAY valve are plugged. Clear. Replace rupture disk. Do not replace with a pipe plug.
				Feed system defective	Check feed pump and hoses for blockage. Check that feed pumps have correct air pressure.



Error	Location	Type	Description	Cause	Solution
P1FA	HCM		Low Inlet Pressure A	Inlet pressure lower than defined value	Ensure that inlet pressure to the pump is sufficient.
				Value defined too high	Ensure that the low pressure alarm level defined on the System Setup screen is acceptable.
P1FB	HCM		Low Inlet Pressure B	Inlet pressure lower than defined value	Ensure that inlet pressure to the pump is sufficient.
				Value defined too high	Ensure that the low pressure alarm level defined on the System Setup screen is acceptable.
P2FA	HCM		Low Inlet Pressure A	Inlet pressure lower than defined value	Ensure that inlet pressure to the pump is sufficient.
				Value defined too high	Ensure that the low pressure alarm level defined on the System Setup screen is acceptable.
P2FB	HCM		Low Inlet Pressure B	Inlet pressure lower than defined value	Ensure that inlet pressure to the pump is sufficient.
				Value defined too high	Ensure that the low pressure alarm level defined on the System Setup screen is acceptable.
P4AX	HCM		High Pressure A	System pressurized before allowing heat to reach setpoint	Pressure in the hose and pumps will increase as the system heats up. Turn on heat and allow all zones to reach the temperature setpoint before turning on the pumps.
				Bad pressure transducer	Verify the ADM pressure reading and the analog gauges at the manifold. Replace transducer if they do not match.
				H-XP2 or H-XP3 system configured as H-30, H-40, or H-50	Alarm level is lower for H-30, H-40 and H-50 than for H-XP2 and H-XP3.. Ensure dial on HCM is set to position "3" for H-XP2 or "4" for H-XP3.





Troubleshooting

Error	Location	Type	Description	Cause	Solution
P4BX	HCM		High Pressure B	System pressurized before allowing heat to reach setpoint	Pressure in the hose and pumps will increase as the system heats up. Turn on heat and allow all zones to reach the temperature setpoint before turning on the pumps.
				Bad pressure transducer	Verify the ADM pressure reading and the analog gauges at the manifold.
				H-XP2 or H-XP3 system configured as H-30, H-40, or H-50	Alarm level is lower for H-30, H-40 and H-50 than for H-XP2 and H-XP3.. Ensure dial on HCM is set to position "3" for H-XP2 or "4" for H-XP3.
P4FA	ADM		A Pump Inlet Leak	Thermal expansion is occurring between the drum and Reactor inlet	Condition the drum material to the ambient temperature of the Reactor.
				Damaged ISO pump inlet ball or seat	Replace the ISO pump inlet ball and seat.
P4FB	ADM		B Pump Inlet Leak	Thermal expansion is occurring between the drum and Reactor inlet	Condition the drum material to the ambient temperature of the Reactor.
				Damaged resin pump inlet ball or seat	Replace the resin pump inlet ball and seat.
P6AX	HCM		Pressure Sensor Error A	Loose/bad connection	Check to ensure the pressure transducer is properly installed and all wires are properly connected.
				Bad sensor	Check if the error follows the transducer. Disconnect transducer cables from the HCM (connectors 6 and 7). Reverse A and B connections and check if the errors follows. If the error follows the transducer, replace the pressure transducer.



Error	Location	Type	Description	Cause	Solution
P6BX	HCM		Pressure Sensor Error B	Loose/bad connection	Check to ensure the pressure transducer is properly installed and all wires are properly connected.
				Bad sensor	Check if the error follows the transducer. Disconnect transducer cables from the HCM (connectors 6 and 7). Reverse A and B connections and check if the errors follows. If the error follows the transducer, replace the pressure transducer.
P6FA	HCM		Pressure Sensor Error Inlet A	Inlet sensors not installed	If inlet sensors are not installed, inlet sensors should be disabled on the System Setup screen.
				Loose/bad connection	Check to ensure inlet sensor is properly installed and all wires are properly connected.
				Bad sensor	Check if the error follows the inlet sensor. Disconnect inlet sensor cables from the HCM (connectors 8 and 9). Reverse A and B connections and check if the errors follows. If the error follows the sensor, replace the inlet sensor.
P6FB	HCM		Pressure Sensor Error Inlet B	Inlet sensors not installed	If inlet sensors are not installed, inlet sensors should be disabled on the System Setup screen.
				Loose/bad connection	Check to ensure inlet sensor is properly installed and all wires are properly connected.
				Bad sensor	Check if the error follows the inlet sensor. Disconnect inlet sensor cables from the HCM (connectors 8 and 9). Reverse A and B connections and check if the errors follows. If the error follows the sensor, replace the inlet sensor.





Troubleshooting

Error	Location	Type	Description	Cause	Solution
P7AX	HCM		Pressure Imbalance A High	Pressure difference between A and B material is greater than the defined value	Ensure material flow is equally restricted on both material lines.
				Pressure imbalance is defined too low	Ensure that the pressure imbalance value, on the System Setup screen, is at an acceptable maximum pressure to prevent unnecessary alarms and abort dispenses.
				Out of material	Fill the tanks with material.
				Fluid leaking from heater inlet rupture disk	Check if heater and PRESSURE RELIEF/SPRAY valve are plugged. Clear. Replace rupture disk. Do not replace with a pipe plug.
				Feed system defective	Check feed pump and hoses for blockage. Check that feed pumps have correct air pressure.
P7BX	HCM		Pressure Imbalance B High	Pressure difference between A and B material is greater than the defined value	Ensure material flow is equally restricted on both material lines.
				Pressure imbalance is defined too low	Ensure that the pressure imbalance value, on the System Setup screen, is at an acceptable maximum pressure to prevent unnecessary alarms and abort dispenses.
				Out of material	Fill the tanks with material.
				Fluid leaking from heater inlet rupture disk	Check if heater and PRESSURE RELIEF/SPRAY valve are plugged. Clear. Replace rupture disk. Do not replace with a pipe plug.
				Feed system defective	Check feed pump and hoses for blockage. Check that feed pumps have correct air pressure.



Error	Location	Type	Description	Cause	Solution
R1D0	ADM		Low Ratio Low Flow A	Damaged ISO pump	Inspect the ISO pump and replace if necessary.
				Fluid leak between ISO pump and meter	Inspect fluid lines for ISO leaks.
				Damaged ISO recirculation valve	Replace the ISO valve.
				Damaged ISO flow meter	Replace the ISO meter.
				ISO material drum is empty	Replace the ISO drum.
				Cavitation in the ISO pump	Increase the ISO feed pump pressure.
R4D0	ADM		High Ratio Low Flow B	Damaged resin pump	Inspect the resin pump and replace if necessary.
				Fluid leak between resin pump and meter	Inspect the fluid lines for resin leak.
				Damaged resin recirculation valve	Replace the resin valve.
				Damaged resin flow meter	Replace the resin meter.
				Resin material drum is empty	Replace the resin drum.
				Cavitation on resin pump	Increase the resin feed pump pressure.
R9AX	ADM		No Pulses A Flow Meter	Damaged ISO flow meter	Replace the ISO meter.
				No ISO flow	Verify that the ISO inlet valves are open.
				The ISO flow meter is clogged	Clean the ISO flow meter.
R9BX	ADM		No Pulses B Flow Meter	Damaged resin flow meter	Replace the resin meter.
				No resin flow	Verify that the resin inlet valves are open.
				Flow resin meter is clogged	Clean the resin flow meter.





Troubleshooting



Error	Location	Type	Description	Cause	Solution
T2DA	Heater A		Low Temperature A	Flow is too high at current setpoint	Use a smaller mix chamber that is rated for the unit in use. If recirculating, decrease flow or decrease temperature setpoint.
				Bad RTD or bad RTD placement against heater	Swap A and B heater output cables and RTD cables and see if issue follows. If so, replace RTD.
				Bad heater element	Confirm resistance of heater. Heater resistance should be 9-12 Ω for 10 kW systems and 6-8 Ω for 15 kW systems. If out of tolerance, replace heater element.
				Loose heater wires	Check for loose heater element wires.
T2DB	Heater B		Low Temperature B	Flow is too high at current setpoint	Use a smaller mix chamber that is rated for the unit in use. If recirculating, decrease flow or decrease temperature setpoint.
				Bad RTD or bad RTD placement against heater	Swap A and B heater output cables and RTD cables and see if issue follows. If so, replace RTD.
				Bad heater element	Confirm resistance of heater. Heater resistance should be 9-12 Ω for 10 kW systems and 6-8 Ω for 15 kW systems. If out of tolerance, replace heater element.
				Loose heater wires	Check for loose heater element wires.
T2DH	Hose		Low Temperature Hose	Flow is too high at current setpoint	Use a smaller mix chamber that is rated for the unit in use. If recirculating, decrease flow or decrease temperature setpoint.
				Cold chemical in unheated portion of system passed hose FTS at startup	Recirculate heated chemical back to drum in cold conditions before startup.





Error	Location	Type	Description	Cause	Solution
T2FA	HCM		Low Temperature Inlet A	Inlet fluid temperature is below the defined level	Recirculate fluid through heaters until inlet fluid temperature is above defined error level.
					Increase the low temperature deviation level on the System Setup screen.
T2FB	HCM		Low Temperature Inlet B	Inlet fluid temperature is below the defined level	Recirculate fluid through heaters until inlet fluid temperature is above defined error level.
					Increase the low temperature deviation level on the System Setup screen.
T3CH	Hose		Hose Cutback	Hose current has been reduced because hose has been drawing current for an extended period	Hose setpoint higher than A and B setpoints. Decrease hose setpoint.
					Hose FTS is in a colder environment than the rest of the hose. Expose FTS to the same environment as the rest of the hose.
T3CT	TCM		TCM Cutback	High ambient temperature	Ensure ambient temperature is below 120°F (48°C) before using the system.
				Enclosure fan not operating	Ensure fan in electrical enclosure is spinning. If it is not, check fan wiring or replace fan.
				Module fan not operating	If a TCM fan error (WMIO) has occurred, fan inside the module is not working properly. Check TCM fan for debris and clear with forced air if necessary.
T4CT	TCM		High Temperature TCM	High ambient temperature	Ensure ambient temperature is below 120°F (48°C) before using the system.
				Enclosure fan not operating	Ensure fan in electrical enclosure is spinning. If it is not, check fan wiring or replace fan.
				Module fan not operating	If a TCM fan error (WMIO) has occurred, fan inside the module is not working properly. Check TCM fan for debris and clear with forced air if necessary.

Troubleshooting





Error	Location	Type	Description	Cause	Solution
T4DA	Heater A		High Temperature A	Bad RTD or bad RTD placement against heater	Swap A and B heater output cables and RTD cables and see if issue follows. If so, replace RTD.
				Flow too high for temperature setpoint, causing temperature overshoots when gun is de-triggered	Use a smaller mix chamber that is rated for the unit in use.
T4DB	Heater B		High Temperature B	Bad RTD or bad RTD placement against heater	Swap A and B heater output cables and RTD cables and see if issue follows. If so, replace RTD.
				Flow too high for temperature setpoint, causing temperature overshoots when gun is de-triggered	Use a smaller mix chamber that is rated for the unit in use.
T4DH	Hose		High Temperature Hose	Hose portion exposed to an excessive heat source, like hot sun or coiled hose, can pass fluid more than 27°F (15°C) over hose temperature setting to the FTS	Shade exposed hose from hot sun or expose FTS to same environment when at rest. Uncoil entire hose before heating to avoid self-heating.
				Setting the A or B setpoint much higher than hose setpoint can cause fluid more than 27°F (15°C) over hose temperature setting to reach the FTS.	Increase hose setpoint so it is closer to A and B setpoints.
				Cold ambient temperature is causing hose to heat	Cold ambient temperature is chilling the FTS and causing hose heat to stay on longer than needed. Insulate the FTS area of the hose so that it heats at the same rate as the rest of the hose.











Error	Location	Type	Description	Cause	Solution
T4EA	Heater A		High Temperature Switch A	Overtemperature switch sensed a fluid temperature above 230°F (110°C)	Heater was delivered too much power, causing the overtemperature switch to open. RTD is not reading properly. After the heater cools down, replace RTD. Switch closes and the error can be cleared when the heater temperature falls below 190°F (87°C).
				Disconnected or loose overtemperature switch cable/connection	If heater is not actually over temperature, check all wiring and connections between the TCM and the overtemperature switches.
				Overtemperature switch failed in the open position	Replace the overtemperature switch.
T4EB	Heater B		High Temperature Switch B	Overtemperature switch sensed a fluid temperature above 230°F (110°C)	Heater was delivered too much power, causing the overtemperature switch to open. RTD is not reading properly. After the heater cools down, replace RTD. Switch closes and the error can be cleared when the heater temperature falls below 190°F (87°C).
				Disconnected or loose overtemperature switch cable/connection	If heater is not actually over temperature, check all wiring and connections between the TCM and the overtemperature switches.
				Overtemperature switch failed in the open position	Replace the overtemperature switch.
T6DA	Heater A		Sensor Error A	Disconnected or loose RTD cable or connection	Check all wiring and connections to the RTD.
				Bad RTD	Switch the RTD with another and see if the error message follows the RTD. Replace RTD if the error follows the RTD.
T6DB	Heater B		Sensor Error B	Disconnected or loose RTD cable or connection	Check all wiring and connections to the RTD.
				Bad RTD	Switch the RTD with another and see if the error message follows the RTD. Replace RTD if the error follows the RTD.

Error	Location	Type	Description	Cause	Solution
T6DH	Hose		Sensor Error Hose	Disconnected or shorted RTD cable in hose or bad FTS	<p>Expose each hose RTD connection to check and retighten any loose connector. Measure hose RTD cable and FTS continuity. See Repair Heated Hose, page 62. Order RTD Test kit 24N365 for measurement.</p> <p>Disconnect the hose RTD and use Hose Manual Mode or Hose Resistance Mode to continue the job until repair can be completed. Hose Resistance Mode requires a saved calibration factor. Refer to your proportioner operation manual to enable Hose Control Modes.</p>
T6DT	TCM		Sensor Error TCM	Shorted RTD cable in hose or FTS	<p>Expose each hose RTD connection to check for exposed and shorted RTD wires. Measure hose RTD cable and FTS continuity. See Repair Heated Hose, page 62. Order RTD Test kit 24N365 for measurement.</p> <p>Disconnect the hose RTD and use Hose Manual Mode or Hose Resistance Mode to continue the job until repair can be completed. Hose Resistance Mode requires a saved calibration factor. Refer to your proportioner operation manual to enable Hose Control Modes.</p>
				Shorted A or B Heater RTD	<p>If the error still occurs with the hose FTS unplugged, one of the heater RTDs is bad. Unplug the A or B RTD from the TCM. If unplugging an RTD fixes the T6DT error, replace the RTD.</p>

Error	Location	Type	Description	Cause	Solution
T8DA	Heater A		No Temperature Rise A	Bad RTD or bad RTD placement against heater	Swap A and B heater output cables and RTD cables and see if issue follows. If so, replace RTD.
				Bad heater element	Confirm resistance of heater. Heater resistance should be 9-12 Ω for 10 kW systems, 6-8 Ω for 15 kW systems, 4-6 Ω for 20 kW systems. If out of tolerance, replace heater element.
				Loose heater wires	Check for loose heater element wires.
				Started spraying before heater reached operating temperature	Wait until operating temperature has been reached before spraying or recirculating.
T8DB	Heater B		No Temperature Rise B	Bad RTD or bad RTD placement against heater	Swap A and B heater output cables and RTD cables and see if issue follows. If so, replace RTD.
				Bad heater element	Confirm resistance of heater. Heater resistance should be 9-12 Ω for 10 kW systems, 6-8 Ω for 15 kW systems, 4-6 Ω for 20 kW systems. If out of tolerance, replace heater element.
				Loose heater wires	Check for loose heater element wires.
				Started spraying before heater reached operating temperature	Wait until operating temperature has been reached before spraying or recirculating.
T8DH	Hose		No Temperature Rise Hose	Started spraying before heater reached operating temperature	Wait until operating temperature has been reached before spraying or recirculating.
V1IT	TCM		Low Voltage CAN	Bad 24 VDC power supply	Check voltage of power supply. Voltage should be 23-25 VDC. If out of tolerance, replace power supply.
V2IT	TCM		Low Voltage CAN	Bad 24 VDC power supply	Check voltage of power supply. Voltage should be 23-25 VDC. If out of tolerance, replace power supply.

Troubleshooting

Error	Location	Type	Description	Cause	Solution
V2MA	TCM		Low Voltage A	Loose connection or tripped circuit breaker	Check wiring for loose connection or tripped circuit breaker.
				Low incoming line voltage.	Measure voltage at circuit breaker and ensure voltage is greater than 195 VAC.
V2MB	TCM		Low Voltage B	Loose connection or tripped circuit breaker	Check wiring for loose connection or tripped circuit breaker.
				Low incoming line voltage	Measure voltage at circuit breaker and ensure voltage is greater than 195 VAC.
V2MH	TCM		Low Voltage Hose	Loose connection or tripped circuit breaker	Check wiring for loose connection or tripped circuit breaker.
				Low incoming line voltage	Measure voltage at circuit breaker and ensure voltage is greater than 195 VAC.
V3IT	TCM		High Voltage CAN	Bad 24 VDC power supply	Check voltage of power supply. Voltage should be 23-25 VDC. If out of tolerance, replace power supply.
V3MA	TCM		High Voltage A	Incoming line voltage is too high	Ensure incoming system power is wired properly. Verify voltage at each circuit breaker is between 195 and 264 VAC.
V3MB	TCM		High Voltage B	Incoming line voltage is too high	Ensure incoming system power is wired properly. Verify voltage at each circuit breaker is between 195 and 264 VAC.
V3MH	TCM		High Voltage Hose	Incoming line voltage is too high	Ensure incoming system power is wired properly. Verify voltage at each circuit breaker is between 195 and 264 VAC.
V4IT	TCM		High Voltage CAN	Bad 24 VDC power supply	Check voltage of power supply. Voltage should be 23-25 VDC. If out of tolerance, replace power supply.
V4MA	TCM		High Voltage A	Incoming line voltage is too high	Ensure incoming system power is wired properly. Verify voltage at each circuit breaker is between 195 and 264 VAC.

Error	Location	Type	Description	Cause	Solution
V4MB	TCM		High Voltage B	Incoming line voltage is too high	Ensure incoming system power is wired properly. Verify voltage at each circuit breaker is between 195 and 264 VAC.
V4MH	TCM		High Voltage Hose	Incoming line voltage is too high	Ensure incoming system power is wired properly. Verify voltage at each circuit breaker is between 195 and 264 VAC.
WMC0	TCM		Software Update Required	TCM software requires update to use Hose Resistance Mode	Update the ADM with software version 4.01.001 or newer. See Update ADM Software, page 71 .
WMI0	TCM		TCM Fan Error	Fan inside TCM is not operating properly	Check for debris in the TCM fan and clear with forced air if necessary.
WSUX	USB		Configuration Error USB	A valid configuration file can't be found for the USB	Insert a system token into the ADM and cycle power. Wait until the lights on the USB port stop flashing before removing token.
WXUD	ADM		USB Download Error	Log download failed	Backup and reformat the USB drive. Retry download.
WXUU	ADM		USB Upload Error	Custom language file failed to upload	Perform normal USB download and use the new disptext.txt file to upload the custom language.
Z1DH	Hose		Low Resistance Hose Wire	Hose section removed or replaced without re-calibration	Re-calibrate the hose. Follow the Calibration Procedure, page 65 .
				Hose wire temperature is too low	Ensure hose wire temperature is above -4 °F (-20 °C).
Z4DH	Hose		High Resistance Hose Wire	Hose section added or replaced without re-calibration	Re-calibrate the hose. Follow the Calibration Procedure, page 65 .
				Hose wire temperature is too high	Ensure hose wire temperature is below 221 °F (105 °C).
Z6DH	Hose		Sensor Error Hose Wire	TCM is unable to sense hose wire resistance	<ul style="list-style-type: none"> • Ensure at least 50 ft (15.2 m) of heated hose is connected to the system. • If the error cannot be cleared or the error regenerates consistently, replace TCM.

Hydraulic Drive System

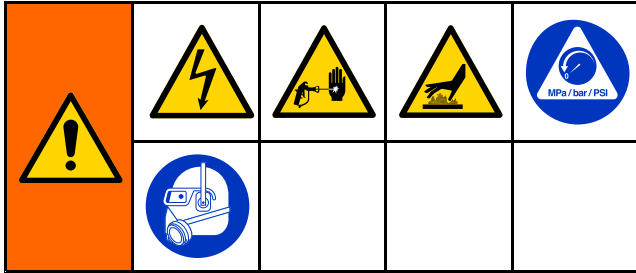

Before performing any troubleshooting procedures:

1. Follow [Pressure Relief Procedure, page 47](#).

2. Turn the main power switch OFF.

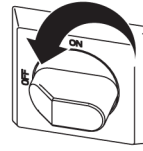

3. Allow equipment to cool.

Try the recommended solutions in the order given for each problem, to avoid unnecessary repairs. Also, determine that all circuit breakers, switches, and controls are properly set and wiring is correct before assuming there is a problem.

NOTE: Motor startup is delayed a maximum of 5 seconds from the last time the motor was turned off to reduce the chance of the motor overheating.

PROBLEM	CAUSE	SOLUTION
Electric motor will not start or stops during operation.	Loose connections and/or contactor (CT01) is not closing.	Check wiring between the following components: <ul style="list-style-type: none"> • HCM and contactor CT01 • HCM and fuses F11/F12
	Damaged HCM.	Replace HCM.
	Loose connections and/or contactor (CT01) is closing.	Check wiring between the following components: <ul style="list-style-type: none"> • motor junction box and CB12 • CB12 • contact CT01 and main disconnect switch (or terminal blocks TB06 and TB09)
	Circuit breaker tripped.	Reset CB12 within the electrical enclosure after confirming wiring is correct and its insulation is intact.

PROBLEM	CAUSE	SOLUTION
<p>Hydraulic pump does not develop pressure. Low or zero pressure with screeching noise.</p>	<p>Pump is not primed or lost its prime.</p>	<p>Check electric motor rotation. Both motor and hydraulic pump must rotate counterclockwise when viewed from shaft end. If rotation is incorrect, reverse leads L1 and L2. See Connect Electrical Cord in Operation manual.</p>
		<p>Check dipstick to ensure that hydraulic reservoir is properly filled (see Operation manual).</p>
		<p>Check that inlet fitting is fully tight, to ensure no air is leaking into the pump inlet.</p>
		<p>To prime pump, run unit at lowest pressure setting and slowly increase pressure. In some cases it may be necessary to remove motor cover and drive belt to allow for manual (counterclockwise) rotation of hydraulic pump. Turn fan pulley by hand. Verify oil flow by removing oil filter to see flow into filter manifold. Reinstall oil filter. Do NOT operate unit without a properly installed oil filter.</p>
	<p>Screeching noise is characteristic of cavitation and is normal at initial startup for a maximum of 30 seconds.</p>	<p>If noise continues longer than 30 seconds, press  to shut off the motor. Check that the inlet fittings are tight and that the pump has not lost its prime.</p>
	<p>Hydraulic fluid is too hot.</p>	<p>Ensure that the reservoir is properly serviced. Improve ventilation to allow more efficient heat dissipation.</p>
	<p>Electric motor operating in wrong direction for 3 Phase system.</p>	<p>Motor must operate counterclockwise from pulley end.</p>
	<p>Drive belt loose or broken.</p>	<p>Check drive belt condition. Replace if broken.</p>

Proportioning System

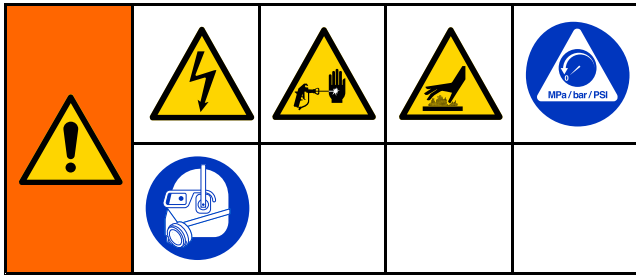

Before performing any troubleshooting procedures:

1. Follow [Pressure Relief Procedure, page 47](#).

2. Turn the main power switch OFF.

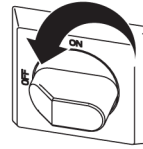

3. Allow equipment to cool.

Problems:

Try the recommended solutions in the order given for each problem, to avoid unnecessary repairs. Also, determine that all circuit breakers, switches, and controls are properly set and wiring is correct before assuming there is a problem.

PROBLEM	CAUSE	SOLUTION
Proportioning pump does not hold pressure when stalled.	Pump piston or intake valve leaking.	<ol style="list-style-type: none"> 1. Observe gauges to determine which pump is losing pressure. 2. Determine in which direction the pump has stalled by observing which directional icon is displayed on the ADM Home screen. See Table 1. 3. Repair the valve. See pump manual.
Material Imbalance. See Pressure/Material Imbalance, page 39 .	Restriction at the gun.	Clean the gun; see your separate gun manual.
	Inadequate flow from pump; cavitation.	Increase fluid supply to proportioning pump: <ul style="list-style-type: none"> • Use 2:1 supply pump • Use minimum 3/4 in. (19 mm) ID supply hose, as short as practical
		Fluid is too thick. Consult your material supplier for the recommended fluid temperature to maintain a viscosity of 250 to 1500 centipoise.
		Clean inlet strainer screen.
	Worn pump inlet valve ball/seat or gasket. Replace pump.	
	Pressure relief/circulation valve leaking back to supply.	Remove return line and determine if flow is present while in SPRAY mode.

PROBLEM	CAUSE	SOLUTION
Pumps do not reverse direction or pumps do not move.	Loose reversing proximity switch.	See Pumps Do Not Reverse Direction, page 40.
	Loose piston packing bolt.	See Pumps Do Not Reverse Direction, page 40.
	Faulty directional valve.	See Pumps Do Not Reverse Direction, page 40.
Erratic pump movement.	Pump cavitation.	Feed pump pressure is too low. Adjust pressure to maintain 100 psi (0.7 MPa, 7 bar) minimum. Fluid is too thick. Consult your material supplier for recommended fluid temperature to maintain a viscosity of 250 to 1500 centipoise.
	Loose reversing proximity switch.	See Pumps Do Not Reverse Direction, page 40.
	Faulty directional valve.	Replace directional valve.
Pump output low.	Obstructed fluid hose or gun; fluid hose ID too small.	Open fluid hose to clear obstruction, or use hose with larger ID.
	Worn piston valve or intake valve in displacement pump.	See pump manual.
	Inadequate feed pump pressure.	Check feed pump pressure and adjust to 100 psi (0.7 MPa, 7 bar) minimum.
Fluid leak at pump rod seal.	Worn throat seals.	Replace. See pump manual.
No pressure on one side.	Fluid leaking from pump outlet rupture disk.	Check if heater and PRESSURE RELIEF/SPRAY valve (SA or SB) are plugged. Clear. Replace rupture disk with a new one; do not replace with a pipe plug.
	Inadequate feed pump pressure.	Check feed pump pressure and adjust to 100 psi (0.7 MPa, 7 bar) minimum.

NOTE: Table 1 is related to troubleshooting problem, "Proportioning pump does not hold pressure when stalled."

Table 1 Determine Valve Leak Location

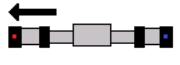
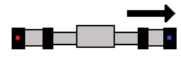
	
B-side pump piston valve is dirty or damaged.	B-side pump inlet valve is dirty or damaged.
A-side pump inlet valve is dirty or damaged.	A-side pump piston valve is dirty or damaged.

Pressure/Material Imbalance



To determine which component is out of balance, check the color of some sprayed material. Two-component materials are usually a mix of light and dark fluids, so the under-proportioned component can often be readily determined.



When you have determined which component is under-proportioned, spray off-target, focusing on the pressure gauge for that component.

For example: if component B is under-proportioned, focus on the B-side pressure gauge. If the B gauge reads considerably higher than the A gauge, the problem is at the gun. If the B gauge reads considerably lower than the A gauge, the problem is at the pump.

Pumps Do Not Reverse Direction

For proportioning pumps to reverse direction, the proximity switches (211) must sense the switching plate (319) to reverse the directional valve (207).

				
<p>DANGER</p> <p>SEVERE ELECTRIC SHOCK</p> <p>This equipment can be powered by more than 240 V. Contact with this voltage will cause death or serious injury. When accessing the electrical enclosure while power is present:</p> <ul style="list-style-type: none"> • Do not make contact with components or wires unless instructed to do so. • Wear appropriate personal protective equipment. <p>See Electrical Schematics, page 102.</p>				

				
<p>The switching plate moves from side to side during operation. Keep hands away from the switching plate, while checking the functionality of the directional valve, to prevent pinching hands.</p>				

1. Check the functionality of each proximity switch (211).
 - a. Remove the front cover.
 - b. With the motor powered off, confirm that the indicating lights on the body of each proximity switch (211) turns on when a metallic item, such as the shaft of a screwdriver, is placed on the face of each switch.
 - c. If the indicating lights turn on, the proximity switches, its wiring, and the HCM are likely operating correctly; proceed to step 2. If the indicating lights do not turn on, proceed to step 6.

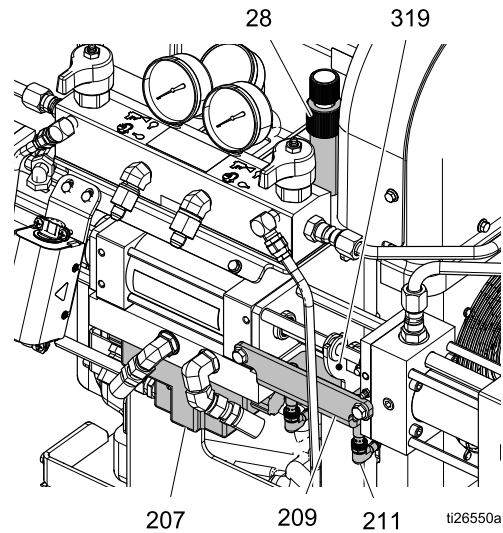

2. Confirm the proximity switches (211), switch bracket (209), and switching plate (319) are firmly mounted and not damaged.
3. Check distance between the proximity switches (211) and the switching plate (319).
 - a. Park the pump.
 - b. Confirm that the proximity switch (211) nearest the A-side of the pump is backed out 0.5 to 1.5 turns from being in contact with the switching plate (319).
 - c. Disconnect the cable from the proximity switch (211) nearest the B-side of the pump. Operate the pump until the switching plate (319) is located above the B-side proximity switch, then turn off the motor/pump.
 - d. Confirm that the proximity switch (211) nearest the B-side of the pump is backed out 0.5 to 1.5 turns from being in contact with the switching plate (319).
 - e. Reconnect the cable to the B-side proximity switch (219).

4. Check functionality of the directional valve (207).
 - a. Confirm that the directional valve cable is connected properly from HCM port 15 to the directional valve body (207) and is not damaged. Inspect wiring inside the cover of the directional valve. See [Electrical Schematics, page 102](#).
 - b. During operation, the direction indicator lights on the directional valve body (207) should switch on based on the valve that is open.
 - c. Turn on the motor and stall the pumps at the lowest pressure setting (compensator knob turned fully counter-clockwise). The pump will travel in either the A or B direction until the pressure setting is reached.
 - d. Identify the solenoid that is operating by viewing the direction indicator lights on the cover of the directional valve (207). Measure voltage across the associated terminals to determine if proper voltage is reaching the valve (approximately 200 to 240 VAC). See [Electrical Schematics, page 102](#), and the table below, to identify the proper terminals to measure across.
 - e. Trigger each proximity switch (211) with the shaft of a screwdriver, confirming each solenoid within the directional valve (207) operates as described in table below.

- f. If one or both sides are not operating properly, according to the table, first reconfirm wiring to directional valve (207) per [Electrical Schematics, page 102](#), then replace directional valve (207).

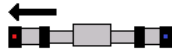
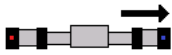
For given pump movement direction:	Pump driving left (toward park position)	Pump driving right (away from park position)
ADM indicates		
Indicator light on directional valve cover	Left arrow, labeled "b"	Right arrow, labeled "a"
Last proximity switch triggered	Right side proximity switch	Left side proximity switch
Terminals in directional valve energized	Terminals associated with red and orange wires	Terminals associated with black and white wires

NOTE: For diagnostic purposes, it is possible to manually override the directional valve by using a small screwdriver to depress the button in the center of either directional valve end cap. Depressing the button in the right end cap should cause the pump to travel to the right. Depressing the left button should cause the pump to travel to the left.

5. If you have determined that the cause is none of the previous possible causes, check for a loose piston packing retaining bolt. This causes the piston to contact the inner face of the pump inlet flange before the switching plate activates the proximity switch. Shut down the unit and disassemble the appropriate pump for repair.
- Following step 1, if the proximity switch indicating lights do not light:**
6. Check for loose or faulty proximity switch cable or connections. Confirm the connections to the proximity switches are tight and internally free from oil and other contaminants.
 7. Swap the cables to the proximity switches to see if the problem follows the switch or is in the cable. Replace either the failed switch or the cable.
 8. Replace the HCM. See [Replace HCM, page 70](#).

Hose Heat System

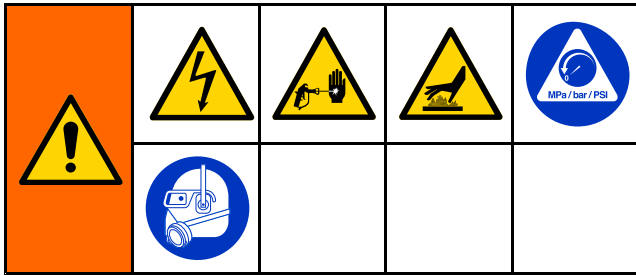

Before performing any troubleshooting procedures:

1. Follow [Pressure Relief Procedure, page 47](#).
2. Turn the main power switch OFF.

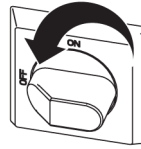

3. Allow equipment to cool.

Problem	Cause	Solution
Hose heats but heats slower than usual or it does not reach temperature.	Ambient temperature is too cold.	Relocate hoses to a warmer area or recirculate heated fluid through the hose.
	FTS failed or not installed correctly.	Check FTS, see Check RTD Cables and FTS, page 62 .
	Low supply voltage.	Verify line voltage. Low line voltage significantly reduces power available to the hose heat system, affecting longer hose lengths.
	If Hose Resistance Mode is enabled, the calibration factor may be inaccurate.	Re-calibrate the hose. Follow the Calibration Procedure, page 65 .
Hose does not maintain temperature while spraying.	A and B setpoints too low.	Increase A and B setpoints. Hose is designed to maintain temperature, not to increase it.
	Ambient temperature is too cold.	Increase A and B setpoints to increase fluid temperature and keep it steady.
	Flow too high.	Use smaller mix chamber. Decrease pressure.
	Hose was not fully preheated.	Wait for hose to heat to correct temperature before spraying.
	Low supply voltage.	Verify line voltage. Low line voltage significantly reduces power available to the hose heat system, affecting longer hose lengths.
	If Hose Resistance Mode is enabled, the calibration factor may be inaccurate.	Re-calibrate the hose. Follow the Calibration Procedure, page 65 .

Problem	Cause	Solution
Hose temperature exceeds setpoint.	A and/or B heaters are overheating material.	Check primary heaters for either an RTD problem or a failed element attached to RTD, see Electrical Schematics, page 102 .
	Faulty FTS connections.	Verify that all FTS connections are snug and that pins of connectors are clean. Unplug and re-plug RTD wires, cleaning off any debris.
	Ambient temperature is too high.	Cover hoses or move to a location with a lower ambient temperature.
	Hose insulation over the FTS location is damaged.	Replace damaged insulation.
	If Hose Resistance Mode is enabled, the calibration factor may be inaccurate.	Re-calibrate the hose. Follow the Calibration Procedure, page 65 .
Erratic hose temperature.	Faulty FTS connections.	Verify that all FTS connections are snug and that pins of connectors are clean. Unplug and re-plug FTS wires along length of hose, cleaning off any debris.
	FTS not installed correctly.	FTS should be installed close to end of hose in same environment as gun. Verify FTS installation, see Repair Fluid Temperature Sensor (FTS), page 64 .
	Missing or damaged insulation around FTS, causing the hose heat to be ON constantly.	Make sure the hose bundle has adequate insulation evenly covering the entire length and connection joints.
Hose does not heat.	FTS failed.	Check FTS, see Repair Fluid Temperature Sensor (FTS), page 64 .
	FTS not installed correctly.	FTS should be installed close to end of hose in same environment as gun. Verify FTS installation, see Repair Fluid Temperature Sensor (FTS), page 64 .
	Loose hose electrical connections.	Check connections. Repair as necessary.
	Circuit breakers tripped.	Reset breakers (CB11 and/or CB15), see Repair Circuit Breaker Module, page 66 .
	Hose zone not turned on.	Turn on hose heat zone.
	A and B temperature setpoints too low.	Check. Increase if necessary.

Troubleshooting

Problem	Cause	Solution
Hoses near Reactor are warm, but hoses downstream are cold.	Shorted connection or failed hose heating element.	With power off, check the hose resistance with and without the whip hose attached. With the whip hose attached, the reading should be less than 3 ohm. Without the whip hose attached, the reading should be OL (open loop). See Check Hose Wires, page 62 .
Low hose heat.	A and B temperature setpoints too low.	Increase A and B setpoints. Hose designed to maintain temperature, not increase temperature.
	Hose temperature setpoint too low.	Check. Increase if necessary to maintain heat.
	Flow too high.	Use smaller mix chamber. Decrease pressure.
	Low current; FTS not installed.	Install FTS, see operation manual.
	Hose heat zone not turned on long enough to reach setpoint.	Allow hose to heat up, or preheat fluid.
	Loose hose electrical connections.	Check connections. Repair as necessary.
	Ambient temperature is too low	Relocate hoses to a warmer area or increase A and B setpoints.
	If Hose Resistance Mode is enabled, the calibration factor may be inaccurate.	Re-calibrate the hose. Follow the Calibration Procedure, page 65 .

Primary Heater

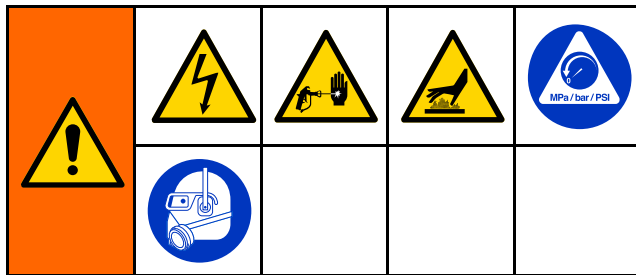

Before performing any troubleshooting procedures:

1. Follow [Pressure Relief Procedure, page 47](#).

2. Turn the main power switch OFF.

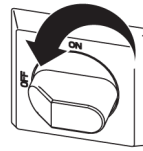

3. Allow equipment to cool.

Try the recommended solutions in the order given for each problem, to avoid unnecessary repairs. Also, determine that all circuit breakers, switches, and controls are properly set and wiring is correct before assuming there is a problem.

Problem	Cause	Solution
Primary Heater(s) does not heat.	Heat turned off.	Turn on heat zones.
	Temperature control alarm.	Check ADM for error codes.
	Signal failure from RTD.	Check ADM for error codes. Confirm RTD cabling is properly connected and not damaged. Replace RTD.
Control of primary heat is abnormal; high temperature overshoots (T4DA, T4DB) occurs intermittently.	Dirty RTD connections.	Examine RTD cables connected to TCM. Confirm RTDs are not plugged into opposite heat zone. Unplug and re-plug RTD connectors. Unplug and re-plug RTD connectors. Ensure RTD tip contacts the heater element.
	RTD not contacting heater element.	Loosen ferrule nut, push in RTD so tip contacts heater element. Holding RTD tip against heater element, tighten ferrule nut 1/4 turn past tight.
	Failed heater element.	See Replace Heater Element, page 60 .
	Signal failure from RTD.	See (T6DA, T6DB), Error Codes .

Flow Meter

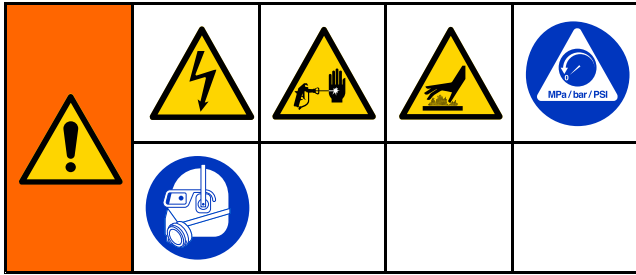

1. Relieve pressure.
See [Pressure Relief Procedure, page 47](#).
2. Turn the main power switch OFF.

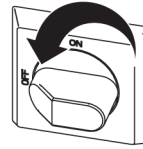

3. Allow equipment to cool.

Try the recommended solutions in the order given for each problem, to avoid unnecessary repairs.

Before performing any troubleshooting procedures:

Problem	Cause	Solution
The material ratio is significantly offset from 1 : 1.	The k-factor entered in the ADM is incorrect.	Update the k-factor. See Replace Flow Meter, page 59
	Cavitation is reducing the pump performance.	Increase the feed pump pressure.
		Install a larger feed pump.
		Clean the y-strainer filter.
		Install a smaller mix chamber in the spray gun.
	Air is trapped in the system, between the feed pumps and the heated hose.	Condition the material in the drums to the ambient temperature of the proportioner.
Re-route the feed hoses to a lower height.		
Purge air from the system. Refer to your ratio monitor manual for instructions.		
The ADM displays low inlet pressure alarms, but the inlet pressure reading appears correct.	While spraying, the inlet pressure drops below 30 psi.	Place the heated hose on flat ground. Spray material into a waste container until all air has left the system.
		Increase the feed pump pressure.
		Install a larger feed pump.
The material flow and ratio are not displayed on the ADM.	The flow meter is disabled.	Install a smaller mix chamber in the spray gun.
		Enable the flow meter on System Screen 1.
The flow meter repeatedly disables itself.	The inlet sensors are disabled.	Enable the inlet sensors. Inlet sensors must be enabled for the flow meter to function.

Pressure Relief Procedure



Follow the Pressure Relief Procedure whenever you see this symbol.

This equipment stays pressurized until pressure is manually relieved. To help prevent serious injury from pressurized fluid, such as skin injection, splashing fluid and moving parts, follow the Pressure Relief Procedure when you stop spraying and before cleaning, checking, or servicing equipment.

The Fusion AP gun is shown.

1. Press to stop the pumps.
2. Turn off all heat zones.

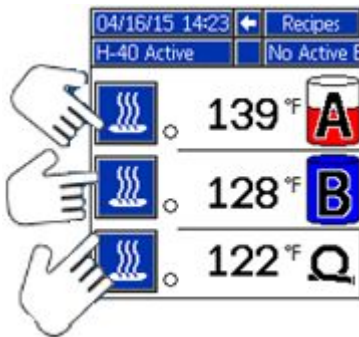

3. Relieve pressure in gun and perform gun shutdown procedure. See gun manual.

4. Close gun fluid inlet valves A and B.

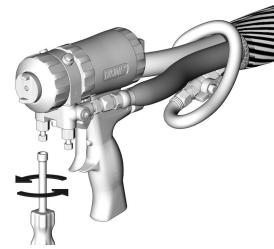

5. Shut off feed pumps and agitator, if used.
6. Route fluid to waste containers or supply tanks. Turn PRESSURE RELIEF/SPRAY valves (SA, SB) to PRESSURE RELIEF/CIRCULATION



Ensure gauges drop to 0.

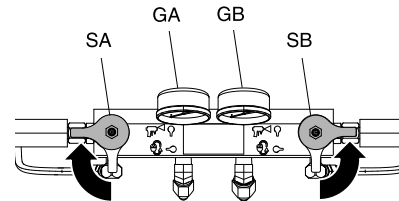

7. Engage gun piston safety lock.



8. Disconnect gun air line and remove gun fluid manifold.

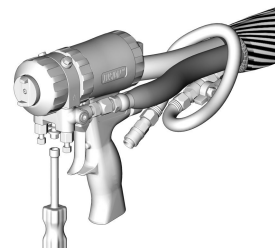

Shutdown

NOTICE

Proper system setup, startup, and shutdown procedures are critical to electrical equipment reliability. The following procedures ensure steady voltage. Failure to follow these procedures will cause voltage fluctuations that can damage electrical equipment and void the warranty.

1. Press  to stop the pumps.
2. Turn off all heat zones.

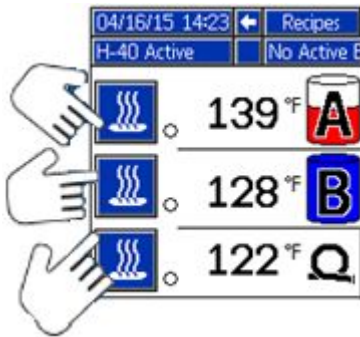

3. Relieve pressure. See [Pressure Relief Procedure, page 47](#).

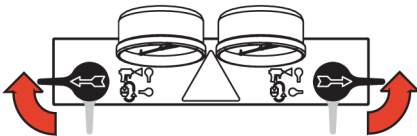

4. Press  to park the Component A and Component B pumps. The park operation is complete when green dot goes out. Verify the park operation is complete before moving to next step.

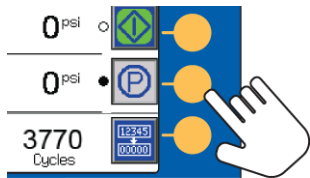

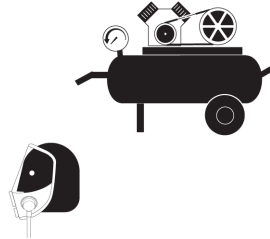

5. Press  to deactivate the system.

6. Turn off the air compressor, air dryer, and breathing air.

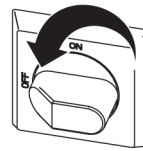

7. Turn the main power switch OFF.



			
To prevent electric shock do not remove any covers or open the electrical enclosure door while the power is ON.			

8. Close all fluid supply valves.

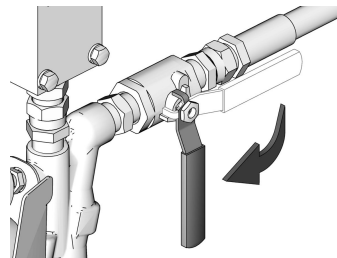

9. Set PRESSURE RELIEF/SPRAY valves to SPRAY to seal out moisture from the drain line.
10. Engage gun piston safety lock then close fluid inlet valves A and B.

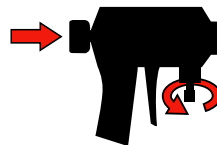

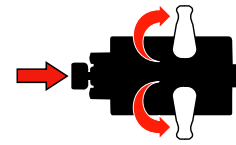

Fusion



Probler

Flushing

				
<p>To avoid fire and explosion:</p> <ul style="list-style-type: none"> • Flush equipment only in a well-ventilated area. • Do not turn on heaters until fluid lines are clear of solvent. • Flush out old fluid with new fluid, or flush out old fluid with a compatible solvent before introducing new fluid. • Use the lowest possible pressure when flushing. • All wetted parts are compatible with common solvents. Use only moisture-free solvents. 				

To flush feed hoses, pumps, and heaters separately from heated hoses, set PRESSURE RELIEF/SPRAY valves (SA, SB) to PRESSURE

RELIEF/CIRCULATION . Flush through bleed lines (N).

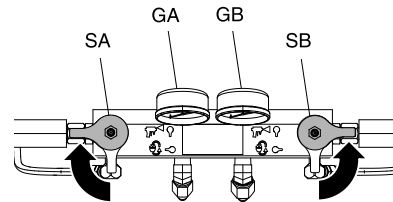

To flush entire system, circulate through gun fluid manifold (with manifold removed from gun).

To prevent moisture from reacting with isocyanate, always leave the system filled with a moisture-free plasticizer or oil. Do not use water. Never leave the system dry. See [Important Two-Component Material Information, page 7](#).

Repair

<p>Repairing this equipment requires access to parts that may cause electric shock or other serious injury if work is not performed properly. Be sure to shut off all power to equipment before repairing.</p>				

Before Beginning Repair

NOTICE
<p>Proper system setup, startup, and shutdown procedures are critical to electrical equipment reliability. The following procedures ensure steady voltage. Failure to follow these procedures will cause voltage fluctuations that can damage electrical equipment and void the warranty.</p>

1. Flush if necessary. See [Flushing, page 49](#).
2. See [Shutdown, page 48](#).

Pumpline Disassembly

1. Follow the [Pressure Relief Procedure, page 47](#).
2. Remove plug fitting (206) from lube cylinder (205).
3. Insert clevis pin removal tool 296607 through opening in lube cylinder (205) and screw tool into left clevis pin (219). Pull clevis pin out of clevis (117).
4. Use hex key to remove four socket head cap screws (203) from left proportioning pump (202). Remove left proportioning pump.
5. Remove lube cylinder (205).
6. Screw pin removal tool 296607 into right clevis pin (219). Pull clevis pin out of clevis (117).
7. Use hex key to remove four socket head cap screws (203) on right proportioning pump (202). Remove right proportioning pump.

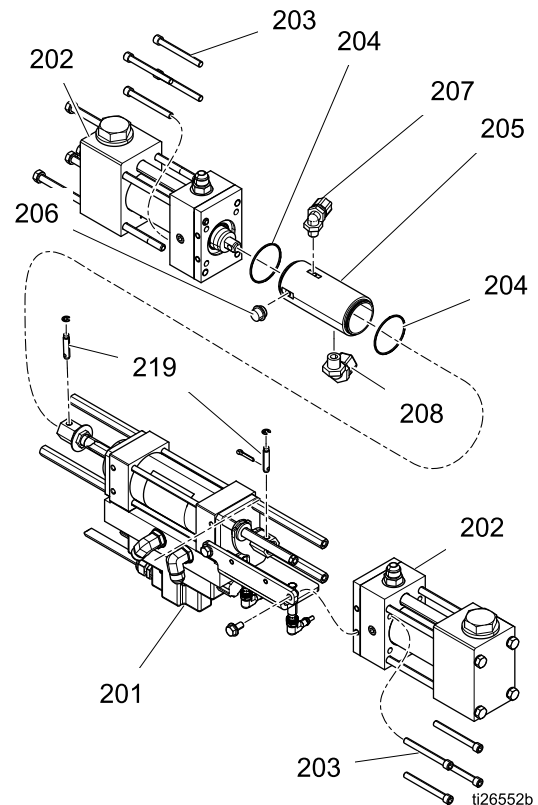

Flush Inlet Strainer Screen

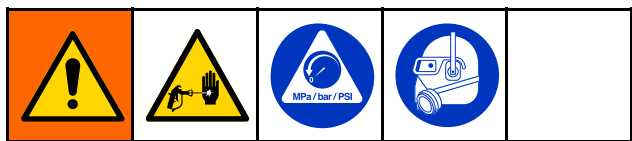

The inlet strainers filter out particles that can plug the pump inlet check valves. Inspect the screens daily as part of the startup routine, and clean as required.

Isocyanate can crystallize from moisture contamination or from freezing. If the chemicals used are clean and proper storage, transfer, and operating procedures are followed, there should be minimal contamination of the A-side screen.

Note

Clean the A-side screen only during daily startup. This minimizes moisture contamination by immediately flushing out any isocyanate residue at the start of dispensing operations.

1. Close the fluid inlet valve on the y-strainer inlet and shut off the appropriate feed pump. This prevents material from being pumped while cleaning the screen.
2. Place a container under the strainer base to catch drain off when removing the strainer plug (C).
3. Remove the screen (A) from the strainer manifold. Thoroughly flush the screen with compatible solvent and shake it dry. Inspect the screen. No more than 25% of the mesh should be restricted. If more than 25% of the mesh is blocked, replace the screen. Inspect the o—ring (B) and replace as required.

4. Ensure the pipe plug (D) is screwed into the strainer plug (C). Install the strainer plug with the screen (A) and o—ring (B) in place and tighten. Do not overtighten. Let the gasket make the seal.
5. Open the fluid inlet valve, ensure that there are no leaks, and wipe the equipment clean. Proceed with operation.

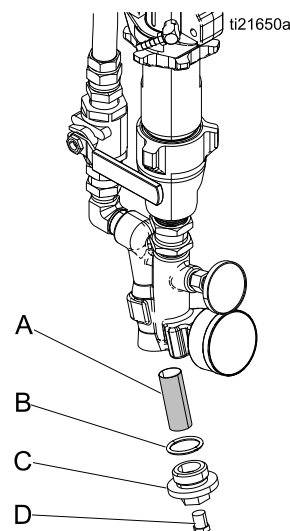

Repair Proportioning Pumps



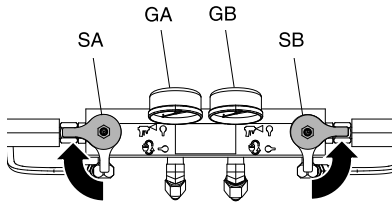

1. Follow [Before Beginning Repair, page 50](#).
2. Turn both Pressure Relief/Spray valve (SA, SB) to Pressure Relief/Circulation. Route fluid to waste containers or supply tanks. Ensure gauges (GA, GB) drop to 0 psi.

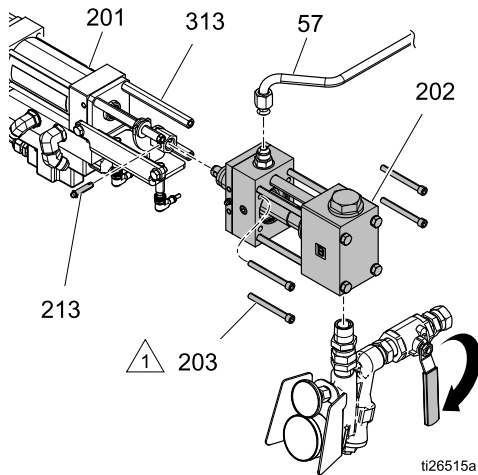

NOTE: Use drop cloth or rags to protect the Reactor and surrounding area from spills.

3. Disconnect the B (Resin) side pump inlet line, the inlet y-strainer, and hard tube (57). Remove the pin (213) from the clevis (317) to disconnect the pump from the hydraulic cylinder (201). Remove the four screws (203) holding the pump to the spacers (313) of the cylinder. Take the pump assembly to a workbench.



 Torque to 200 in.-lb (22.6 N•m).

4. Disconnect the A (ISO) side pump inlet line, the inlet y-strainer, and hard tube (55). Use the pin extractor tool (101) to remove the pin (213), which disconnects the pump from the hydraulic cylinder (201). Remove the four screws (203) holding the pump to the spacers (313) of the cylinder. Take the pump assembly to a workbench.

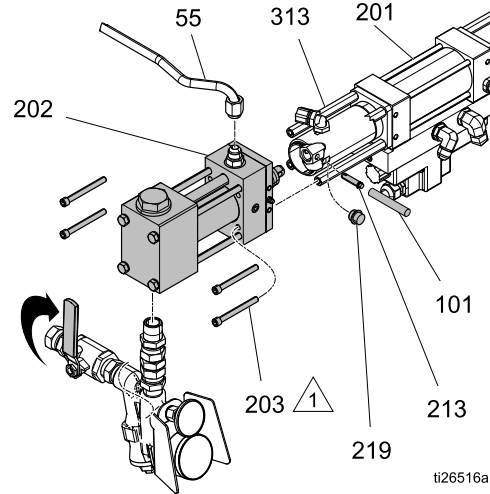

 Torque to 200 in.-lb (22.6 N•m).

5. See pump manual for repair instructions.
6. Reconnect the pump in the reverse order. Torque the screws to 200 in.-lb (22.6 N•m)

Clean Flow Meter

1. Perform [Shutdown](#), page 48.
2. Perform [Pressure Relief Procedure](#), page 47.
3. Disconnect the flow meter cable.
4. Disconnect the heated hose from the flow meter. Remove the flow meter.
5. Remove four screws (VS) and remove the top cover (PL).

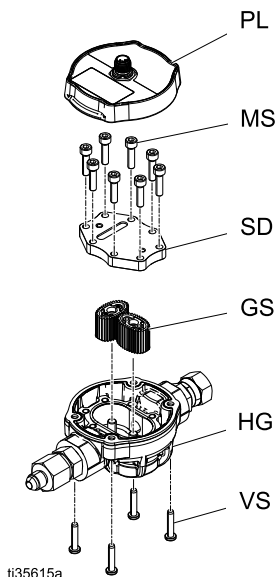

6. Remove eight screws (MS) and remove the metal cap (SD).
7. Remove gears (GS) from the housing (HG).
8. Clean the gears and the fluid section of the housing with compatible solvent.

9. Reinstall the gears.
 - a. Place the gear with the magnets (MG) on the left pin of the housing.

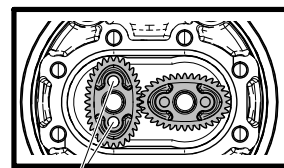

MG

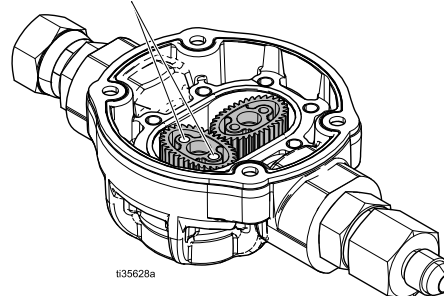

NOTE: The gear with the magnets (MG) must be installed on the left side or the meter will not function. Install the gears as shown.

- b. Position the gears perpendicular (90°) to each other and install the rounded bottom (RB) of the gear into the housing.

NOTE: Turn the gears to make sure that they stay engaged and rotate together once installed. Reinstall the gears if they do not stay engaged or rotate together.

10. Reinstall the flow meter. Reconnect the heated hose and flow meter cable.

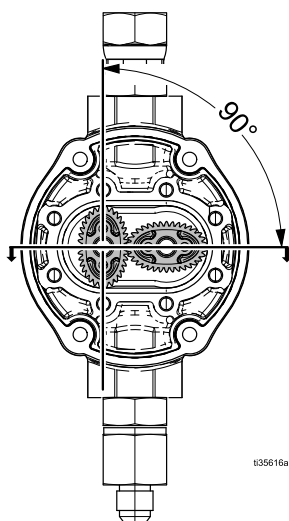

t35616a

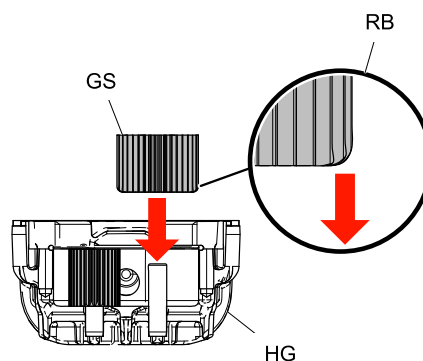

3. Place a pan under the reservoir drain plug (16f) to catch oil.

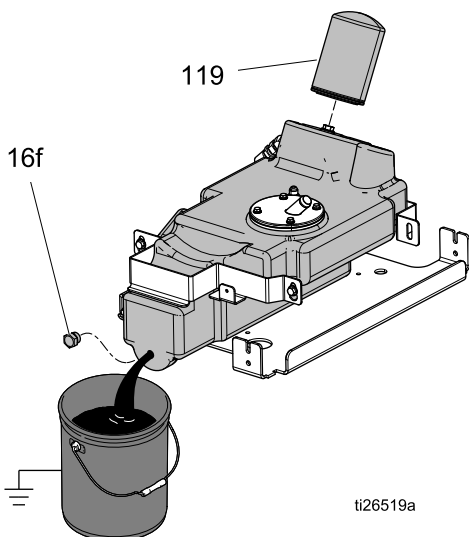

4. Remove the drain plug (16f).
5. Place a rag around base of oil filter (119) to prevent oil from spilling. Unscrew filter 1/4-3/4 turn to break air lock in filter. Wait five minutes to allow oil in filter to drain back into reservoir. Unscrew filter and remove.
6. Reinstall drain plug (16f).
7. Replace filter (119):
 - a. Coat filter seal with fresh oil.
 - b. Screw filter on snug, then an additional 1/4 turn.
8. Refill reservoir with approved hydraulic fluid. See Table 3.
9. Proceed with normal operation.

NOTE: Upon starting motor, hydraulic pump may make a screeching noise until primed. If this noise continues for more than 30 seconds, switch off motor control.

Table 3 Approved Anti-Wear (AW) Hydraulic Oils

Supplier	Name
Citgo	A/W ISO Grade 46
Amsoil	AWI ISO Grade 46 (synthetic*)
BP Oil International	Energol® HLP-HM, ISO Grade 46
Carl Bechem GmbH	Staroil HVI 46
Castrol	Hyspin AWS 46
Chevron	Rykon® AW, ISO 46
Exxon	Humble Hydraulic H, ISO Grade 46
Mobil	Mobil DTE 25, ISO Grade 46
Shell	Shell Tellus, ISO Grade 46
Texaco	Texaco AW Hydraulic, ISO Grade 46
* Note: Do not mix mineral-based and synthetic hydraulic oils. Completely drain oil from reservoir and pump prior to converting between oils.	
If the approved oils are not available in your area, use an alternative hydraulic oil meeting the following requirements:	
Oil Type: Anti-Wear (AW) Hydraulic	
ISO Grade: 46	
Viscosity, cSt at 40°C: 43.0-47.0	
Viscosity, cSt at 100°C: 6.5-9.0	
Viscosity Index: 95 or higher	
Pour Point, ASTM D 97: -15°F (-26°C) or lower	
Other essential properties: Formulated for anti-wear, anti-foaming, oxidation stability, corrosion protection, and water separation.	

Replace Electric Motor

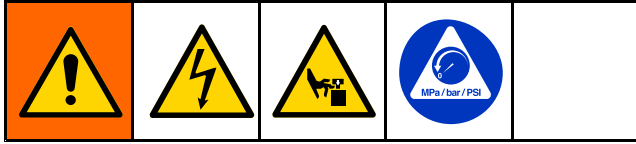

Remove

NOTICE

Be careful not to drop or damage the motor. The motor is heavy and may require two people to lift.

1. Follow [Shutdown](#), page 48.
2. Open electrical enclosure. Disconnect the A side heater connector from the TCM. See [Electrical Schematics](#), page 102. Close the electrical enclosure door.
3. Remove mounting bolts from the bottom frame and move the system away from the wall.

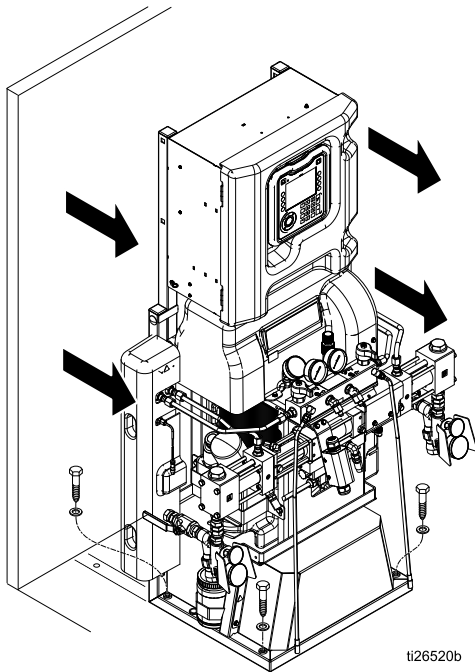

Figure 2

4. Remove upper bolts (3). Tilt the electrical enclosure down to gain access to the motor cover.

5. Remove motor and belt covers (123, 131, 132). Lift cover (132) and loosen the blue bracket (131) fasteners. Lift the blue bracket (133) off of the fasteners and set aside. Remove the belt covers (131, 132).

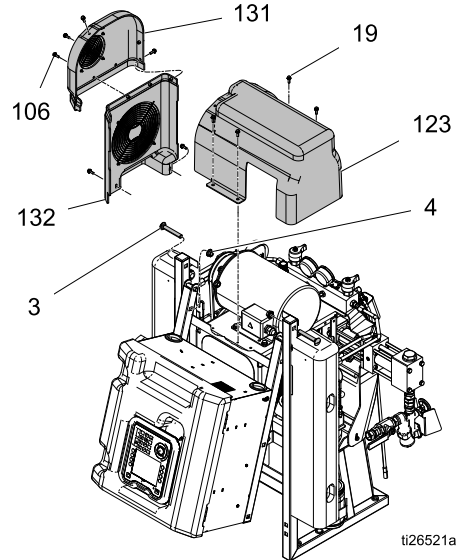

Figure 3 Motor and Belt Covers

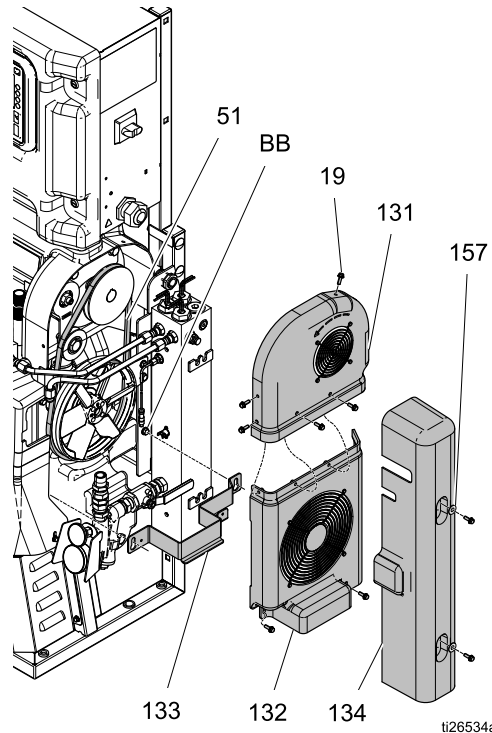

Figure 4 Heater and Belt Covers

- Remove the belt (51). See [Replace Belt, page 58](#). Remove the two pulley screws (48) and the belt tensioning assembly from the motor.

NOTICE

To prevent damage to cables, do not crush or strain any cables near the point where the frame halves hinge.

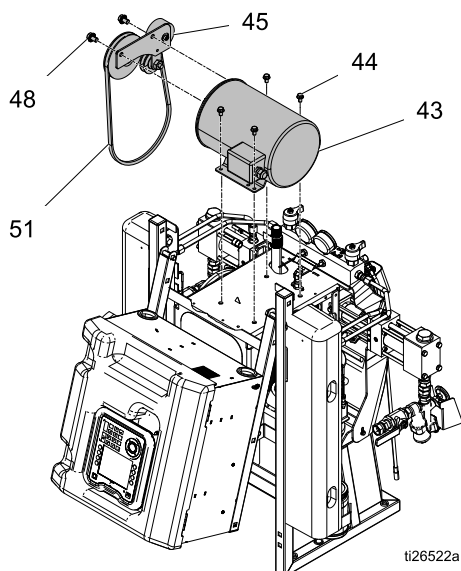

Figure 5 Motor and Belt Assembly

- Remove the electric motor junction box cover (43).
- Disconnect the motor cables. See [Electrical Schematics, page 102](#).

- Note or label the wire connections. See the [Electrical Schematics, page 102](#) and the diagram inside the motor junction box cover. The motor must operate counter-clockwise when looking at the output shaft.
- Remove the motor.

Installation

- Place the motor on the unit.
- Fasten the motor with bolts.
- Connect the wires, using wire nuts. See [Electrical Schematics, page 102](#), and the diagram inside the motor junction box.

Note

For 3-Phase Motors, the motor must rotate counterclockwise when viewed from the shaft end. If rotation is incorrect, reverse power leads L1 and L2. Follow **Connect Electrical Cord** instructions in the system operation manual.

- Replace bracket (133) and the belt and heater covers (131, 132, 134).
- Raise electrical enclosure into the vertical position and ensure wires are not pinched between the frame halves. Replace and tighten bolts (3).
- Open electrical enclosure. Connect the A side heater connector the TCM.
- Secure the system to original mounting location.
- Return to service.

Replace Flow Meter

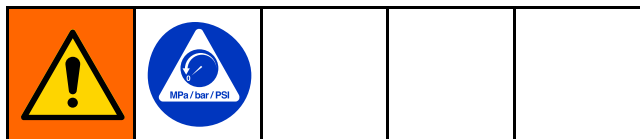

NOTE: For H-30, H-40, and H-50 Elite models only.

1. Perform [Shutdown](#), page 48.
2. Perform [Pressure Relief Procedure](#), page 47.
3. Disconnect the flow meter cable.
4. Disconnect the hose. Remove the flow meter.
5. Install the new flow meter and reconnect the hose.

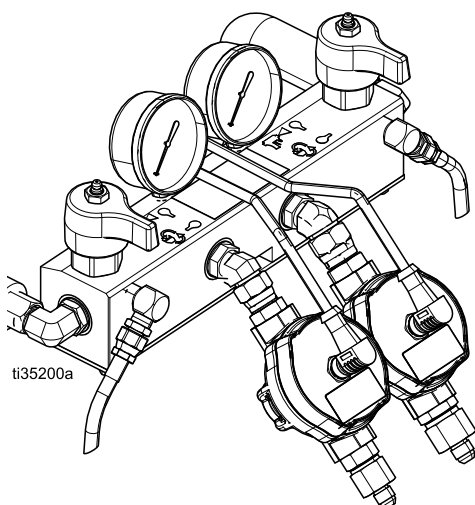
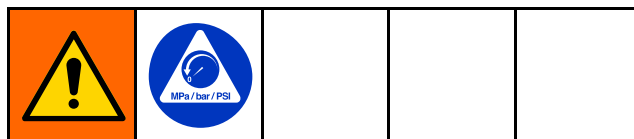

Figure 6 : Flow Meter

6. Connect the flow meter cable.
7. Enter the k-factor on System Screen 3 on the ADM. Refer to **System 3** in your Reactor operation manual.

Replace Pressure Transducers



1. Flush. See [Flushing](#), page 49.
2. See [Shutdown](#), page 48.
3. Disconnect transducer cables (405) from #6 and #7 connectors on the HCM.
4. Remove wire ties constraining transducer cable and remove cable from cabinet.
5. Install o-ring (406) on new transducer (405).
6. Install transducer in manifold. Mark end of cable with tape (red=transducer A, blue=transducer B).
7. Route new cable into cabinet and thread into bundle as before. Attach cable ties to bundle as before.
8. Connect A side pressure transducer cable to HCM port #6. Connect B side pressure transducer cable to HCM port #7.

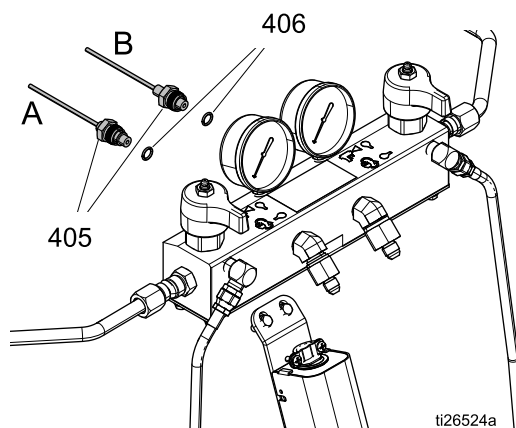

Repair Primary Heater



Replace Heater Element

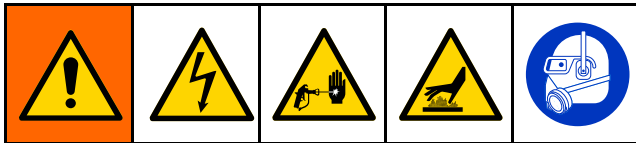

1. Follow [Before Beginning Repair, page 50](#).
2. Wait for heaters to cool.
3. Remove heater cover.
4. Disconnect heater element wires from heater wire connector inside the electrical enclosure. See [Electrical Schematics, page 102](#). Test with an ohmmeter.

System	Total Heater Wattage	Element	Ohms per element
H-30	10 kW	2,550	18–21
H-30, H-40, H-XP2	15 kW	2,550	18–21
H-40, H-50, H-XP3	20 kW	2,550	18–21

5. If the RTD is on the heater element, remove the RTD (512) to avoid damage. See [Replace RTD, page 61](#).
6. Use a wrench to remove the heater element (508). Inspect element. It should be relatively smooth and shiny. Replace element if there is a crusted, burnt ash-like material adhered to the element, or if the sheath shows pitting marks.
7. Install the new heater element (508), holding the mixer (510) so it does not block the RTD port. Torque to 120 ft-lb (163 N•m).
8. Install the RTD (512), if removed earlier. See [Replace RTD, page 61](#).
9. Reconnect the wires inside the electrical enclosure.

Line Voltage

The heater outputs its rated wattage at 230 VAC. Low line voltage will reduce power available and the heater will not perform at full capacity.

Repair Heater Overtemperature Switch

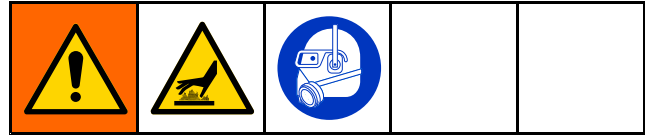

1. Perform [Shutdown, page 48](#).
2. Wait for heaters to cool.
3. Remove heater cover (#10).
4. Disconnect overtemperature switches (509) from cable (88). Test across spade terminals with ohmmeter.
 - a. If the resistance is not approximately 0 ohms, the overtemperature switch (509) needs to be replaced. Go to step 5.
 - b. If the resistance is approximately 0 ohms, inspect cable (88) to ensure it is not cut or open. Reconnect the overtemperature switch (509) and cable (88). Disconnect cable from the TCM. Test from pin 1 to 3 and 1 to 4. If the resistance is not approximately 0, and switches are 0, replace cable in place or original cable.
5. If the switch fails the test, remove the screws. Discard the failed switch. Apply a thin layer of thermal compound 110009 and install a new switch (509) in the same location on housing (501). Secure with screws (513) and reconnect cables (88).

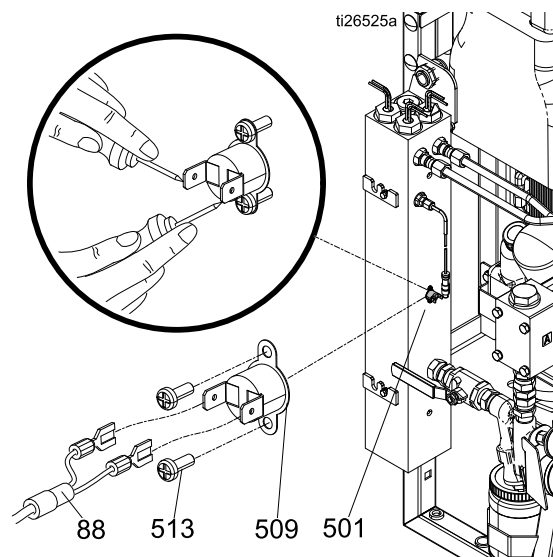

Replace RTD

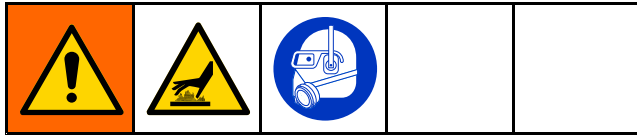

1. Perform [Shutdown, page 48](#).
2. Wait for heater to cool.
3. Remove heater covers.
4. Cut cable ties around the woven wrap with the RTD cable (512).
5. Disconnect RTD cable (512) from TCM (453).
6. Loosen ferrule nut (N). Remove RTD (512) from heater housing (501), then remove RTD housing (H). Do not remove the adapter (206) unless necessary. If adapter must be removed, ensure that mixer (510) is out of the way when replacing the adapter.
7. Remove RTD cable (512) from woven wrap.
8. Replace RTD cable (512).
 - a. Apply PTFE tape and thread sealant to male pipe threads and tighten RTD housing (H) into adapter (506).
 - b. Push in RTD (512) so tip contacts heater element (508).
 - c. Holding RTD (512) against heater element, tighten ferrule nut (N) 3/4 turn past finger-tight.
9. Route wires (S) as before through woven wrap and reconnect RTD cable (512) to the TCM.
10. Replace heater covers.
11. Follow startup instructions in the operation manual. Turn on A and B heat simultaneously to test. Temperatures should rise at same rate. If one is low, loosen ferrule nut (N) and tighten RTD housing (H) to ensure RTD tip contacts the heater element (212) when ferrule nut (N) is retightened.

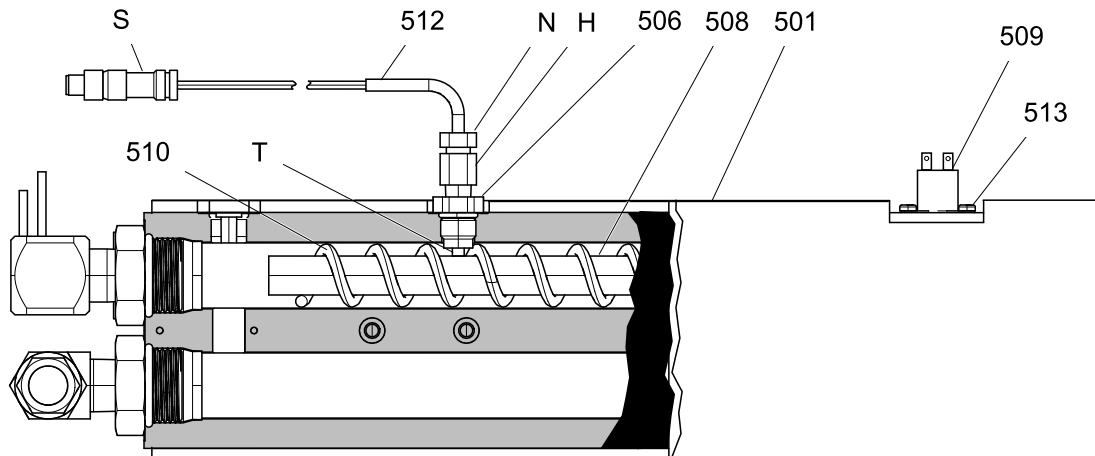

ti26526a

Figure 7

Repair Heated Hose

Refer to the heated hose manual 309572 for hose replacement parts.

Check Hose Wires

1. Perform [Shutdown](#), page 48.
NOTE: Whip hose must be connected.
2. Remove cover (CV).
3. Disconnect system wires from the Reactor.
4. Disconnect hose wires (HW) from terminal block (TB), see Fig 3.
5. Using an ohmmeter, check between the hose wires (HW). There should be continuity.
6. If hose fails test, retest at each length of hose from the system out to the gun, including whip hose, until failure is isolated.
7. Reconnect wires and install cover (CV).

Check RTD Cables and FTS

1. Perform [Shutdown](#), page 48.
2. Disconnect RTD cable (C) at Reactor (SC).
3. Test with an ohmmeter between pins of M8 cable connector C.

NOTE: Do not touch outer ring with test probe while measuring resistance.

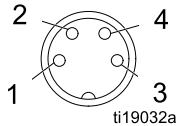

M8 Connector Pins	Resistance
3 to 1	See RTD Resistance vs. Temperature , page 63.
3 to 4	See RTD Resistance vs. Temperature , page 63.
1 to 4	0.2 - 0.4 ohms at the FTS (each 50 ft cable adds 2.5 ohms)
2 to any	infinity (open)

4. Retest at each length of hose, including whip hose, until failure is located.
5. If the FTS is not reading properly at the end of the hose, connect FTS directly to RTD cable (C) at the manifold.
6. If the FTS reads properly at the manifold but not at the end of the hose, check cable (C) connections. Verify they are tight.

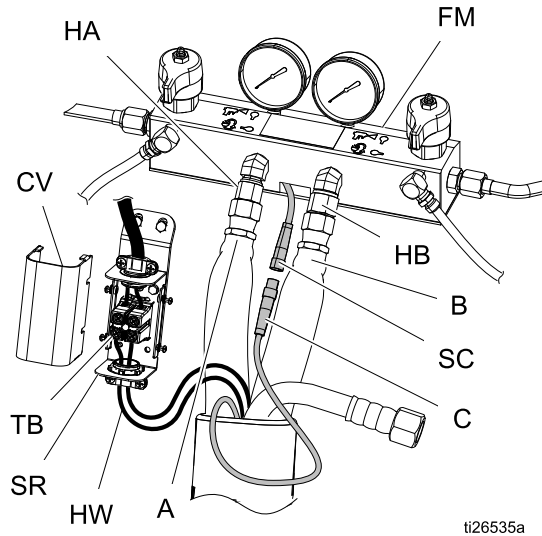

Heated Hose
Figure 8

NOTE: To assist in taking readings, order RTD Test Kit 24N365. Kit includes two cables: one cable with a compatible female M8 connector and another cable with a male M8 connector. Both cables have stripped wire at the other end for easy test probe access.

Pins / Wire Color	Result
3 to 1 / brown to blue	See RTD Resistance vs. Temperature , page 63.
3 to 4 / blue to black	See RTD Resistance vs. Temperature , page 63.
1 to 4 / brown to black	0.2 - 0.4 ohms at the FTS (each 50 ft cable adds 2.5 ohms)
2 to any / N/A	infinity (open)

RTD Resistance vs. Temperature

Approximate Resistance (Ohms)	Temperature °C (°F)
843	-40 (-40)
882	-30 (-22)
922	-20 (-4)
961	-10 (14)
1000	0 (32)
1039	10 (50)
1078	20 (68)
1117	30 (86)
1155	40 (104)
1194	50 (122)
1232	60 (140)
1271	70 (158)
1309	80 (176)
1347	90 (194)
1385	100 (212)

Repair Fluid Temperature Sensor (FTS)

Installation

The Fluid Temperature Sensor (FTS) is supplied with the system. Install FTS between main hose and whip hose. See Heated Hose manual 309572 for instructions.

Test/Removal

1. Perform [Shutdown, page 48](#).
2. Remove tape and protective covering from FTS. Disconnect hose cable (F).
3. If FTS is not reading properly at the end of the hose, see [Check RTD Cables and FTS, page 62](#).
4. If FTS fails, replace FTS.
 - a. Disconnect air hoses (C,L) and electrical connectors (D).
 - b. Disconnect FTS from whip hose (W) and fluid hoses (A, B).
 - c. Remove ground wire (K) from ground screw on underside of FTS.
 - d. Remove FTS probe (H) from component A (ISO) side of hose.

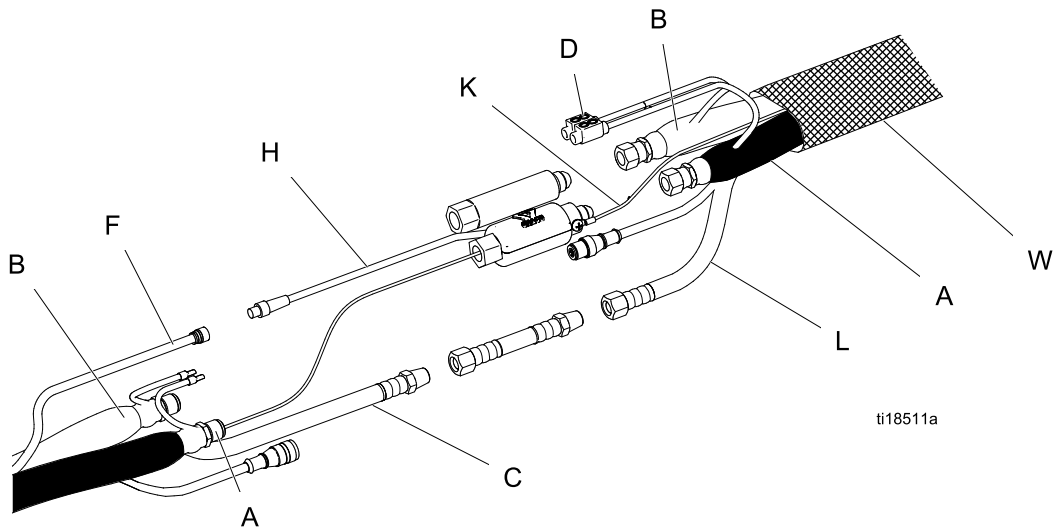



ti18511a

Calibration Procedure



NOTICE	
To prevent damage to the heated hose, a hose calibration is required if any of the following conditions are true:	
<ul style="list-style-type: none"> • The hose has never been calibrated before. • A section of hose has been replaced. • A section of hose has been added. • A section of hose has been removed. 	

NOTE: The Reactor and heated hose must be at the same ambient temperature to get the most accurate calibration.



1. Enter Setup Mode and navigate to System screen 3, then press the Calibrate soft key 

07/10/19 11:59	Advanced	System	Cellular
H-40 Active	No Active Errors		
			
Hose Control Mode:		FTS	
Hose Calibration Factor:		Manual Resistance	
Last Calibration Date:		06/07/19	
<div style="display: flex; align-items: center;"> <div style="border: 1px solid black; padding: 2px; margin-right: 5px;">2</div> <div style="border: 1px solid black; padding: 2px; margin-right: 5px;">3</div> <div style="border: 1px solid black; padding: 2px;">1</div> </div>			
 Calibrate			

2. Press the Continue soft key  to acknowledge the reminder to have the hose at ambient conditions.

07/10/19 11:59	Advanced	System	Cellular
H-40 Active	No Active Errors		
Hose Calibration For best results, calibrate with hose at room temperature.			
 Continue			
 Cancel			

3. Wait while the system measures the hose resistance.

07/10/19 11:59	Advanced	System	Cellular
H-40 Active	No Active Errors		
Hose Calibration Measuring Hose Resistance... 			
 Cancel			

NOTE: If hose heat was on prior to the calibration procedure, the system will wait up to five minutes to allow the wire temperature to equalize.

07/10/19 11:59	Advanced	System	Cellular
H-40 Active	No Active Errors		
Hose Calibration Waiting for hose wire temperature to equalize... <div style="font-size: 2em; font-weight: bold; text-align: center;">0:52</div>			
 Cancel			

NOTE: The hose temperature must be above 32 °F (0 °C) during calibration.

07/10/19 11:59	Advanced	System	Cellular
H-40 Active	No Active Errors		
Hose Calibration Unable to sense hose temperature! (< 32°F)			
 Cancel			

- Accept or cancel the hose calibration.

NOTE: A temperature estimate will be displayed if the system was able to measure the hose wire resistance.

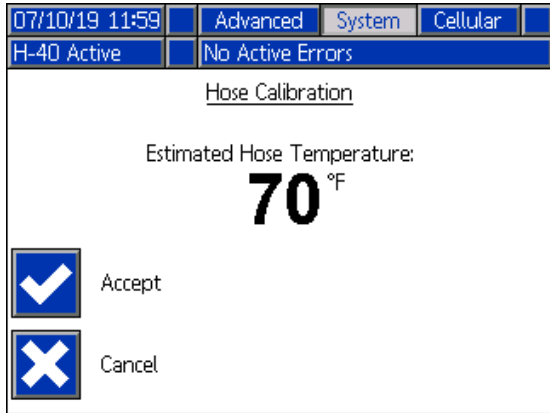

Repair Circuit Breaker Module

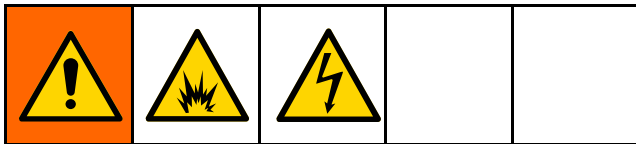

- Follow [Before Beginning Repair, page 50](#).
- Using an ohmmeter, check for continuity across the circuit breaker (top to bottom). If no continuity, trip the breaker, reset, and retest. If there still is no continuity, replace the breaker as follows:
 - Refer to [Electrical Schematics, page 102](#).
 - Perform [Shutdown, page 48](#).
 - Refer to the circuit breaker identification table and electrical diagrams.
 - Loosen the screws connecting the wires to the circuit breaker that will be replaced. Disconnect wires.
 - Pull the locking tab out 1/4 in. (6 mm) and pull circuit breaker away from the din rail. Install the new circuit breaker. Insert wires and tighten down all screws.

Table 4 H-30, H-XP2 Circuit Breakers

Ref.	Size	Component	Part
853 (CB11)	50A, 1 pole	Heated Hose	17A319
854 (CB12)	20A, 2 pole	Motor	17A314
855 (CB13)	40A, 2 pole	Heater A	17A317
855 (CB14)	40A, 2 pole	Heater B	17A317
855 (CB15)	40A, 2 pole	Transformer Primary	17A317

The diagram shows a side view of a circuit breaker module mounted on a DIN rail. Labels point to various components: 852 (top left), 853 (top left pole), 854 (top middle pole), 855 (top right pole), 852 (top right), 857,858 (wires on the left), 856 (bottom middle), and 851 (DIN rail on the right). The part number 'ti26487a' is also indicated.

Table 5 H-40, H-50, H-XP3 Circuit Breakers

Ref.	Size	Component	Part
853 (CB11)	50A, 1 pole	Heated Hose	17A319
859 (CB12)	20A, 3 pole	Motor	17G724
854 (CB13)	60A, 2 pole	Heater A	17G723
854 (CB14)	60A, 2 pole	Heater B	17G723
855 (CB15)	40A, 2 pole	Transformer Primary	17A317

The diagram shows a side view of a circuit breaker module mounted on a DIN rail. Labels point to various components: 852 (top left), 853 (top left pole), 859 (top middle pole), 854 (top middle pole), 854 (top middle pole), 855 (top right pole), 852 (top right), 851 (DIN rail on the right), 857,858 (wires on the left), and 856 (bottom middle). The part number 'ti26484a' is also indicated.

Transformer Primary Check

See [Electrical Schematics, page 102](#).

1. Check wires and transformer:
 - a. See [Shutdown, page 48](#).
 - b. Shut off CB15.
 - c. Use an ohmmeter to test for continuity between terminals 2 and 4 of CB15. If there is no continuity, check transformer and wiring between CB15 and TB31 located behind the lower cover. Go to step 2.
2. Check transformer and TB31:
 - a. See [Shutdown, page 48](#).
 - b. Remove the lower cover.
 - c. Locate the two smaller (10 AWG) wires, labeled 1 and 2, coming out of transformer. Trace these wires back to terminal blocks TB31.
 - d. Use an ohmmeter to test for continuity between two wires; there should be continuity.

Transformer Secondary Check

See [Electrical Schematics, page 102](#).

1. Check wires and transformer:
 - a. See [Shutdown, page 48](#).
 - b. Disconnect 7 pin green connector from TCM.
 - c. Use an ohmmeter to test for continuity between terminals 6 and 7 on the TCM 7 pin green connector. There should be continuity. If there is no continuity, check transformer and wiring.
 - d. Leave 7 pin green connector disconnected from TCM.

2. Check transformer:
 - a. Remove lower cover.
 - b. Locate the two larger (6 AWG) wires, labeled 3 and 4, coming out of transformer. Trace these wires back to TB31. Use an ohmmeter to test for continuity between two transformer wires in terminal block TB31; there should be continuity.
 - c. Reconnect the 7 pin green connector to the TCM.
 - d. Apply incoming power to system.
 - e. To verify voltage on the secondary leads of the transformer, measure between the transformer leads labeled 3 and 4 at TB31. Verify the transformer output voltage is approximately 37.5% of the system supply voltage for H-30 and H-XP2 systems or approximately 50% of system supply voltage for H-40, H-50, and H-XP3. For example, with a 240 VAC system supply voltage the transformer output voltage for an H-30 or H-XP2 would be (.375 x 240V), or approximately 90V; for an H-40, H-50, or H-XP3 it would be (.50 x 240V), or approximately 120V.
 - f. See the Diagnostic Run Screen on the ADM. The Diagnostic Run Screen displays the transformer output voltage (approximately 90 or 120 VAC) under "Hose Voltage". The diagnostic screen will show a Hose Voltage of "0" volts if the circuit breaker has been tripped for the incoming power to the TCM.

NOTE: The Diagnostic Run Screen is disabled by default and must be enabled in the Setup screens. See the Operation manual for instructions.

04/16/15 13:58	Job Data	Diagnostic	Recipes
H-40 Active	No Active Errors		
A Chemical	B Chemical	Hose Chemical	
70 °F	70 °F	70 °F	
A Current	B Current	Hose Current	
0 A	0 A	0 A	
TCM PCB			
70 °F			
A Voltage	B Voltage	Hose Voltage	
230 V	230 V	90 V	
Pressure A	Pressure B		
501 psi	478 psi		
	CPM	Total Cycles	
	60	38	

Replace Transformer

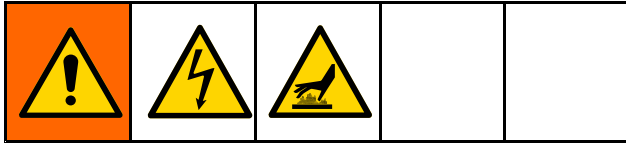

1. Perform [Shutdown, page 48](#) .
2. Remove four bolts (23) and shroud (10).
3. Remove lower dinrail cover (48).
4. Disconnect fan and transformer connections from terminal blocks. Connections are on left side labeled: V+, V-, 1, 2, 3, and 4.
5. Remove four nuts (27) holding metal transformer cover (8) to frame. Carefully remove cover while sliding wires through hole in cover.
6. Remove nuts (27) and transformer (17).
7. Install transformer (17) in reverse order.

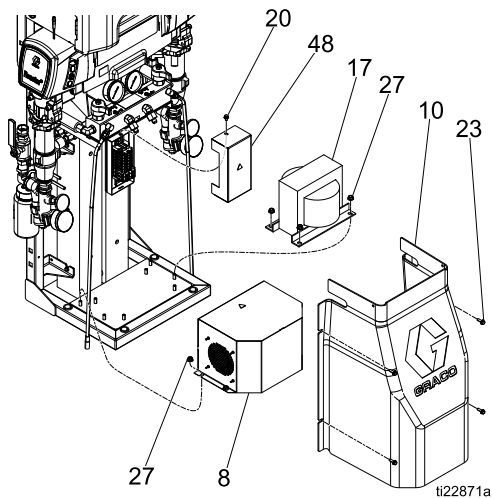

Replace Power Supply

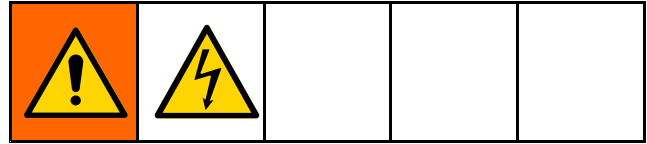

1. Perform [Shutdown, page 48](#).
2. Disconnect input and output cables from both sides of the power supply (805). See [Electrical Schematics, page 102](#).
3. Insert a flat head screw driver in the mounting tab on the bottom of the power supply (805) to remove from the din rail.
4. Install new power supply (805) in reverse order.

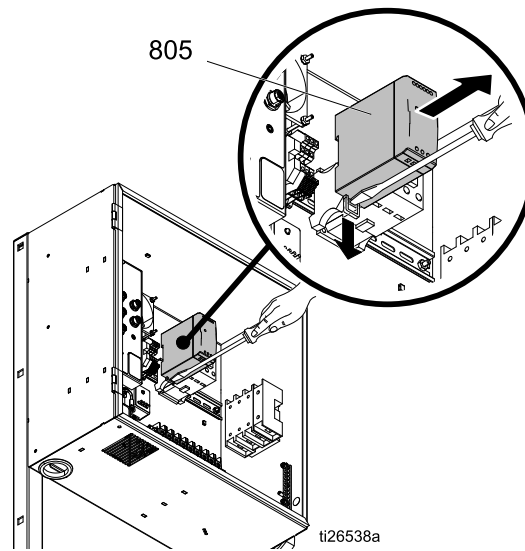

Figure 9 24 VDC Power Supply

Replace Surge Protector

1. Loosen connections on terminals 1 and 3 on CB13. See [Electrical Schematics, page 102](#).
2. Loosen connections on input to power supply (805) on N and L connections. See [Electrical Schematics, page 102](#).
3. Remove two screws (612), washers (611), and surge protector (705) from enclosure.
4. Install new surge protector (705) in reverse order.

NOTE: Wire on both the circuit breaker and power supply are interchangeable.

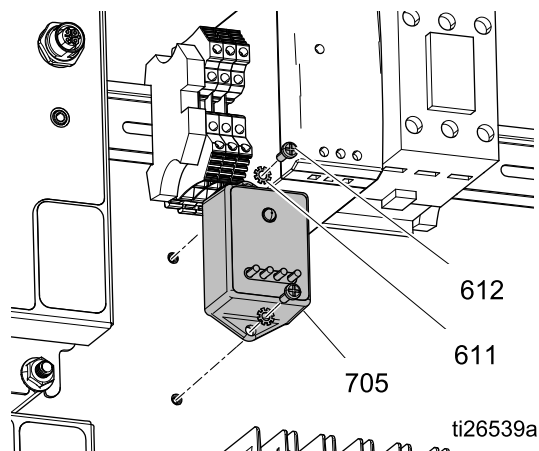

Figure 10 Surge Protector

Replace Temperature Control Module (TCM)

1. Perform [Shutdown, page 48](#).
2. Open the electrical enclosure door.
3. Disconnect all connectors from the TCM (602).
4. Remove four nuts (610) and TCM (602).
5. Install new TCM module (602). Reassemble parts in reverse order.
6. Update software by inserting an upgrade token into the ADM and cycling system power. Wait until the update is complete before removing the token and restarting the system.

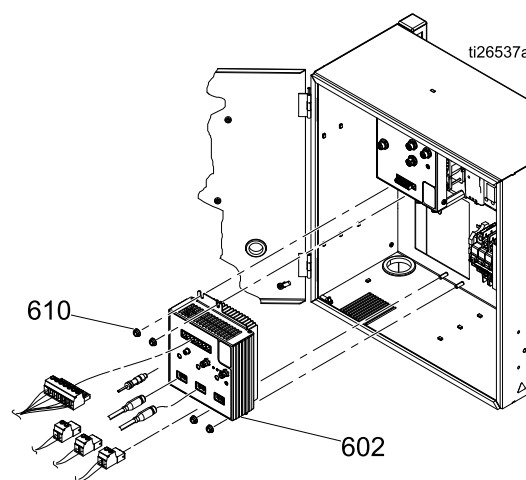

Figure 11 Replace TCM

Replace HCM

1. Follow [Before Beginning Repair, page 50](#).
2. Open the electrical enclosure and disconnect all cables from the HCM (603).
3. Remove the nuts (610) and HCM (603).
4. Set rotary switch.

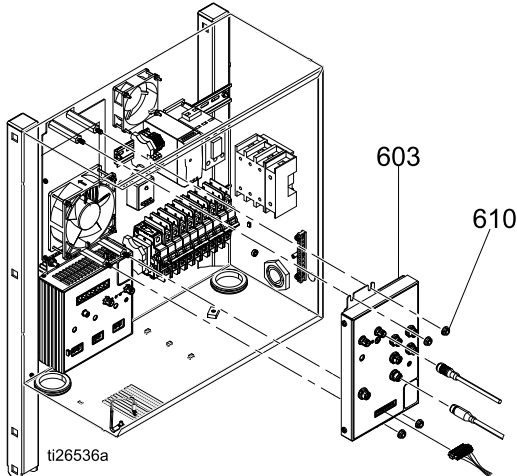

Figure 12 Replace HCM

HCM Rotary Switch Positions

- 0 = Reactor 2, H-30
- 1 = Reactor 2, H-40
- 2 = Reactor 2, H-50
- 3 = Reactor 2, H-XP2
- 4 = Reactor 2, H-XP3

Replace ADM

1. Loosen four screws (142) on the inside of the electrical enclosure door. Lift up and pull out to remove ADM (140).
2. Disconnect CAN cable (622).
3. Inspect ADM (140) for damage. Replace if necessary.
4. Update software by installing an upgrade token into ADM and cycling system power. Wait until the update is complete before removing the token and restarting the system.

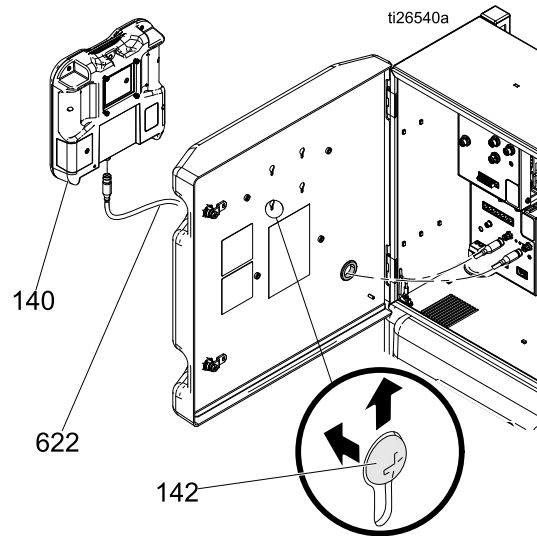

Figure 13

Software Update Procedure

NOTICE

Repair kit GCA modules are shipped pre-programmed and with upgrade token (part number 17E206). If software version upgrade is necessary, follow the procedure in the manual provided.

Update ADM Software

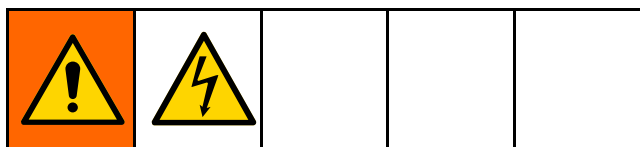

1. Turn the main power switch OFF.

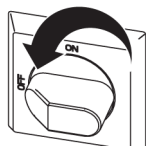

2. Open the top and bottom door latches to the electric cabinet.
 3. Open the electrical cabinet. Use a Phillips screwdriver to loosen the four ADM mounting screws on the inside of the cabinet door.
 4. Lift the ADM up and pull it away from the Reactor to unseat the mounting screws. For easy reassembly, leave the loosened screws attached to the ADM.
 5. Remove the token access panel on the back of the ADM.
 6. Insert and press the software upgrade token firmly into the slot.
- NOTE:** There is no preferred orientation of the token.
7. Close the electrical cabinet.
 8. Turn the main power switch ON.

NOTICE

A status is shown while software is updating to indicate progress. To prevent corrupting the software load, do not remove the token until the status screen disappears.

NOTE: When the ADM display turns on, you may see the following screens:

<p>First: <i>Software is checking which modules will take the available updates.</i></p>	
<p>Second: <i>Status of the update with approximate time until completion.</i></p>	
<p>Third: <i>Updates are complete. Icon indicates update success/failure. See the following table.</i></p>	

Icon	Description
	Update successful
	Update unsuccessful
	Update complete, no changes necessary
	Modules were updated or did not require an update; however, one or more modules need to be updated manually with a token.

9. Press  to continue to the operation screen.
10. Turn the main power switch OFF.
11. Remove the software update token.
12. Replace the token access panel.
13. Open the electrical cabinet, remount the ADM, and fully tighten the four mounting screws.
14. Close the lock and the cabinet door with the door latches.

Parts

Elite Proportioners

Elite Proportioner	Description	Proportioner see Proportioner Parts , page 73.	Elite Kit see manual 3A3084
17H131	H-30	17H031	17F838
17H132	H-30	17H032	17F838
17H143	H-40	17H043	17F838
17H144	H-40	17H044	17F838
17H145	H-40	17H045	17F838
17H146	H-40	17H046	17F838
17H153	H-50	17H053	17F838
17H156	H-50	17H056	17F838
17H162	H-XP2	17H062	17F838
17H174	H-XP3	17H074	17F838
17H176	H-XP3	17H076	17F838

Proportioner Parts

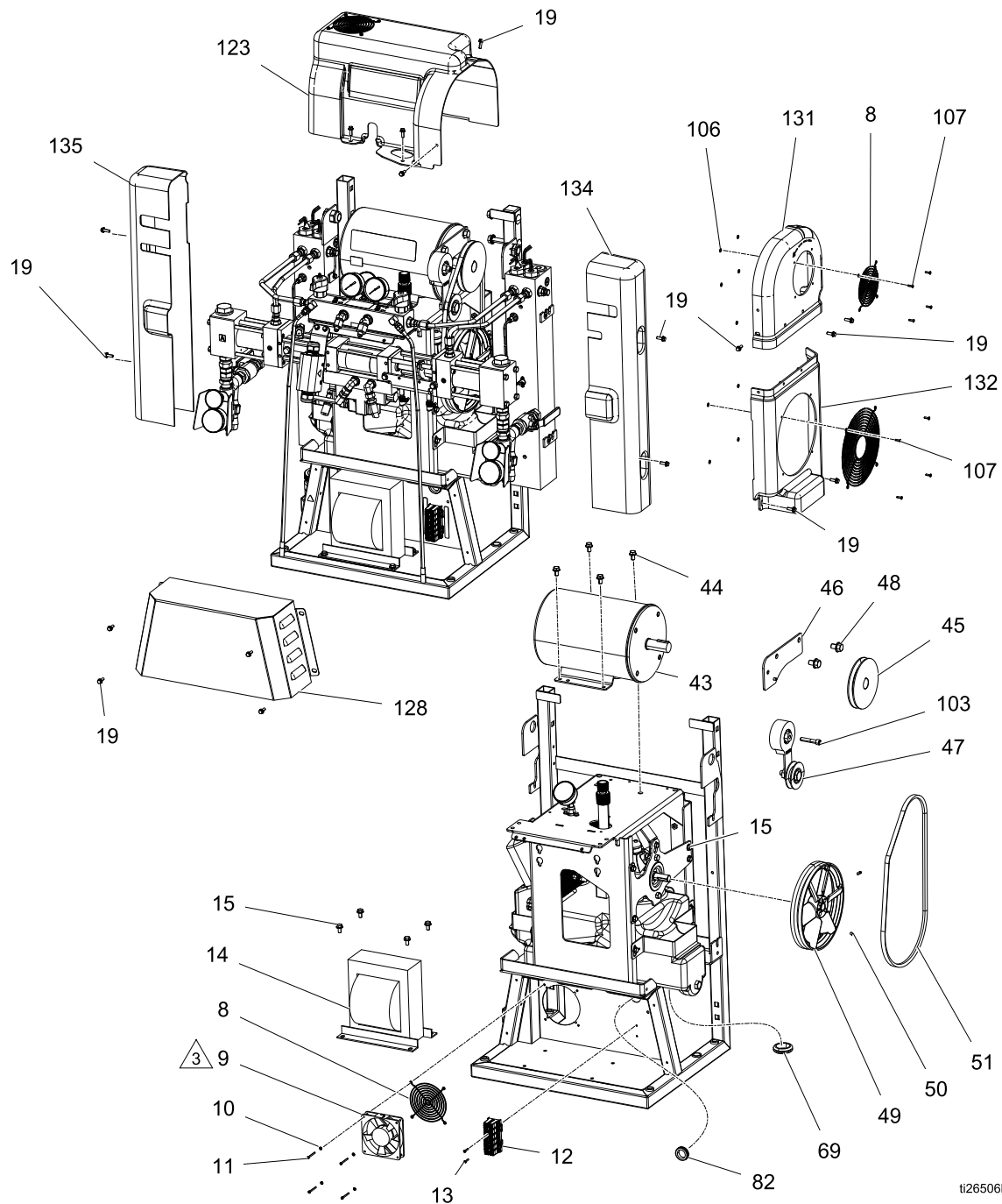



ti26506b

- 1. Apply anaerobic pipe sealant to all non-swiveling pipe threads.
- △ 3 Ensure that the fan (9) direction arrow points away from the mounting panel.

- △ 4 Install pulley (45) flush with motor shaft (43).
- △ 5 Install pulley (44) overhung on pump shaft (27) by .18 +/- .03 in. On models 17H031, 17H032, and 17H074: Install pulley (49) .49 +/- .03 in. from pump shaft (27) end.

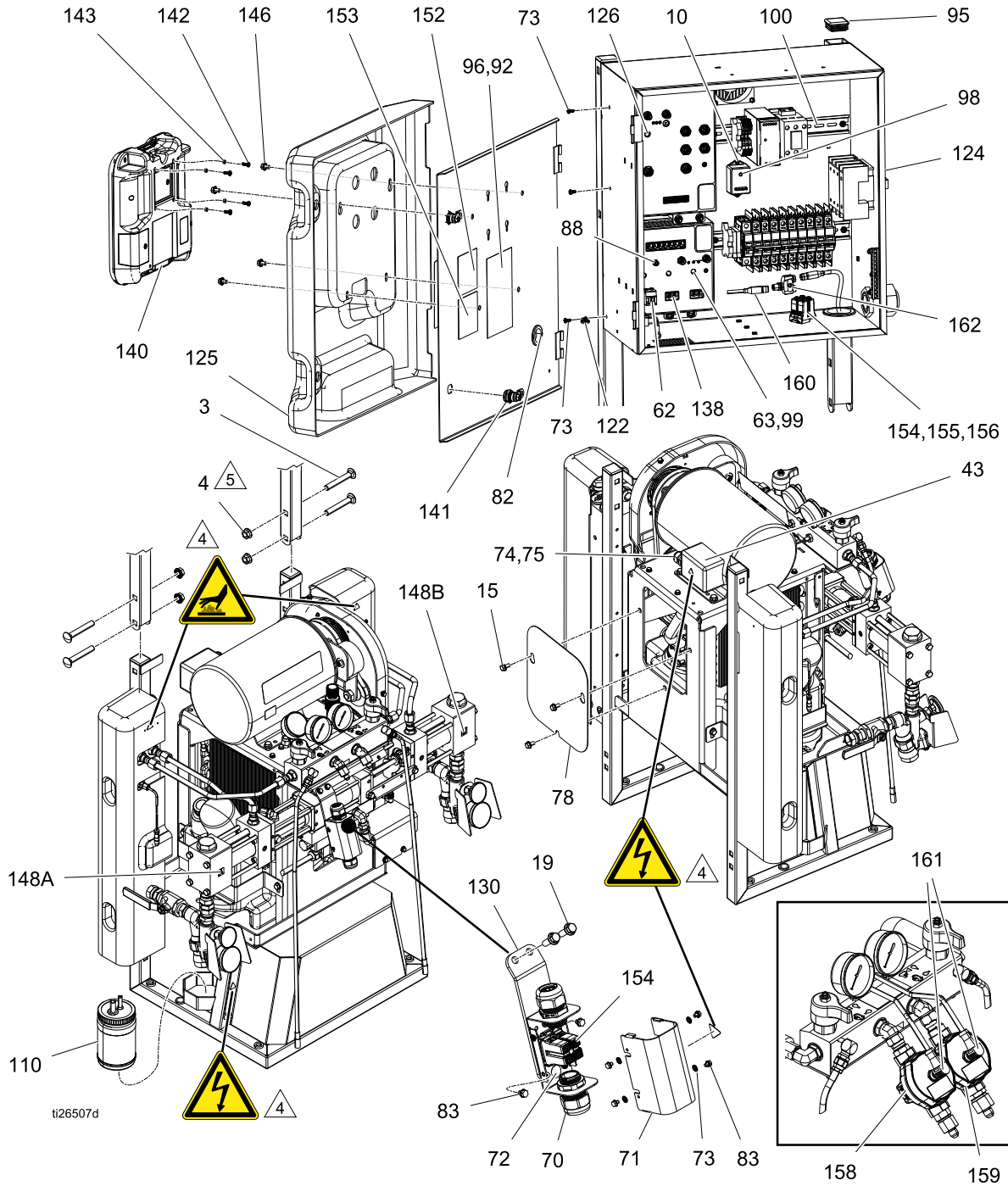
Parts



1. Apply anaerobic pipe sealant to all non-swiveling pipe threads.
Labels are from safety label (629) included in the Electrical Enclosure. See [Electrical Enclosure, page 93](#).
-  Apply single component thixotropic anaerobic sealant to threads..
- 

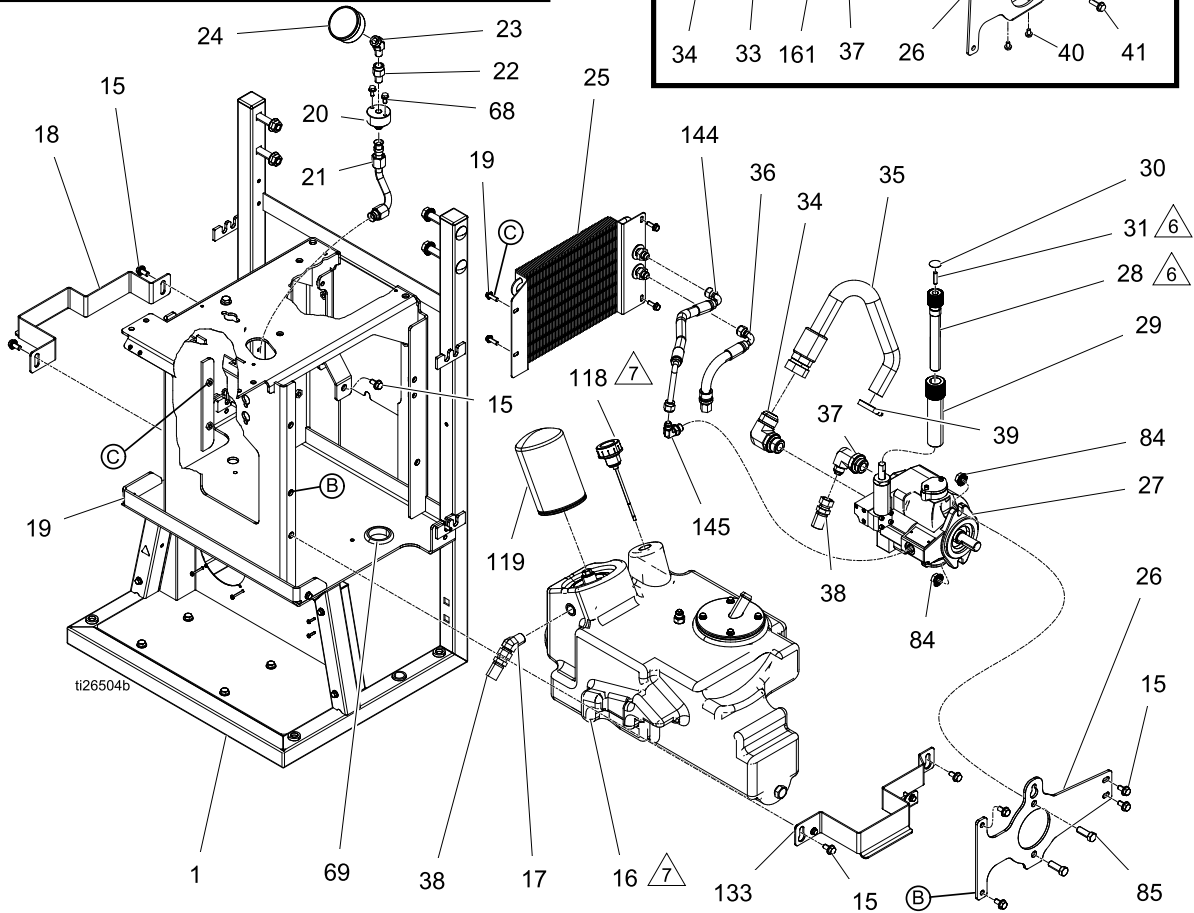
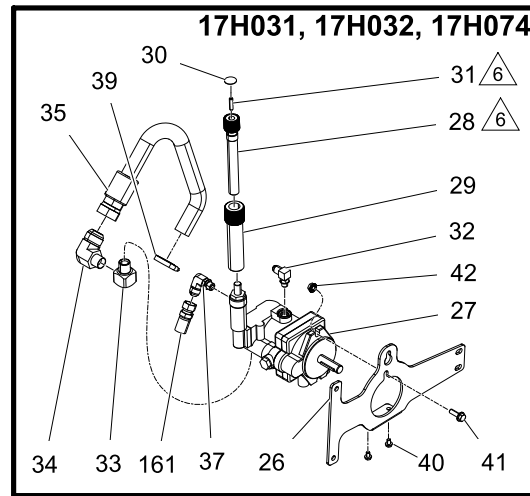
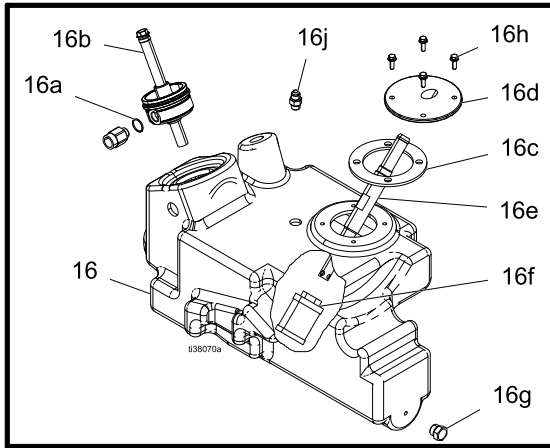



1. Apply anaerobic pipe sealant to all non-swiveling pipe threads.

 Apply high viscosity anaerobic sealant to threads.

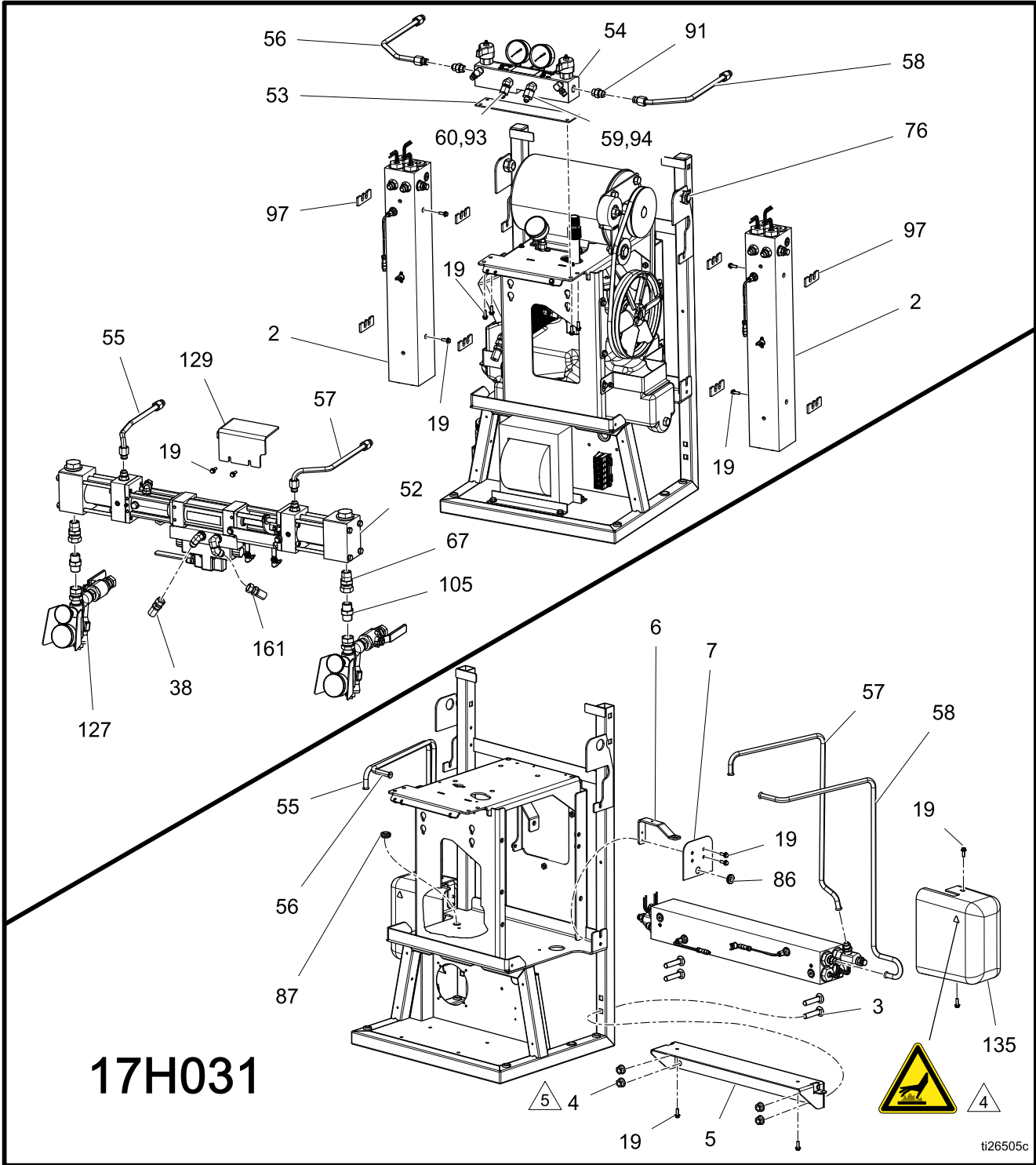
 Fill reservoir (16) with hydraulic oil.



1. Apply anaerobic pipe sealant to all non-swiveling pipe threads.
-  Labels are from safety label (629) included in the Electrical Enclosure. See [Electrical Enclosure, page 93](#).
-  Apply single component thixotropic anaerobic sealant to threads.

H-30, H-XP2

Ref.	Part	Description	Quantities		
			H-30		H-XP2
			17H031	17H032	17H062
1	- - -	CART	1	1	1
2	17G646	HEATER, 7.5kw, 1 zone, rtd		2	2
	17G647	HEATER, assy, 10.2kw, 2 zone, rtd	1		
3	127277	BOLT, carriage, 1/2-13 x 3.5 l	8	4	4
4	112731	NUT, hex, flanged	8	4	4
5	17G618	BRACKET, 10kw, hanger	1		
6	17G617	BRACKET, 10kw, shroud	2		
7	17G619	BRACKET, 10kw, guard	2		
8	115836	GUARD, finger	2	2	2
9	24U847	FAN, cooling, 120mm, 24vdc	1	1	1
10	103181	WASHER, lock ext	4	4	4
11	117683	SCREW, mach, phil pan hd	4	4	4
12	17G680	BLOCK, terminal, 6 pole	1	1	1
13	- - -	SCREW, 3/4 in, #6-32	2	2	2
14	247812	TRANSFORMER, 4090va, 230/90	1	1	1
15	111800	SCREW, cap, hex hd	20	20	20
16	277411	RESERVOIR, hydraulic, Reactor, molded	1	1	1
16a	107079	PACKING, o-ring	1	1	1
16b	15J616	TUBE, return, reservoir, hydraulic	1	1	1
16c	15J718	GASKET, inlet	1	1	1
16d	15J811	HOUSING, inlet, reservoir	1	1	1
16e	15J810	TUBE, inlet, reservoir	1	1	1
16f	17V598	FILTER, screen, suction, hydraulic (not shown)	1	1	1
16g	120765	FITTING, plug, sae	1	1	1
16h	113796	SCREW, flanged, hex hd	4	4	4
16j	120663	FITTING, straight, hydraulic	1	1	1
16k	070289	SEALANT, anaerobic (not shown)	1	1	1
16m	15J612	HEAD, filter, spin on (not shown)	1	1	1
16n	15J613	STEM, return, oil, reservoir (not shown)	1	1	1
17	117556	FITTING, nipple, #8 jic x 1/2 npt	1	1	1
18	17G621	BRACKET, retaining, tank	1	1	1
19	113796	SCREW, flanged, hex hd	33	35	35
20	- - -	ADAPTER, hydraulic gauge	1	1	1
21	17G624	TUBE, gauge, pressure	1	1	1
22	15H524	ACCUMULATOR, pressure, 1/4 npt	1	1	1
23	119789	FITTING, elbow, street, 45 deg	1	1	1
24	112567	GAUGE, pressure, fluid	1	1	1
25	247829	COOLER, hydraulic, complete	1	1	1
26	17G611	BRACKET, mntg, pump, hyd, lf	1	1	1
27	247855	PUMP, hydraulic	1	1	1
27a	129375	KEY, square	1	1	1
28*	- - -	KNOB, compensator	1	1	1
29*	- - -	KNOB, lock, compensator	1	1	1
30	15H512	LABEL, control	1	1	1
31*	- - -	SCREW, set, 1/4-20 sst	1	1	1
32	110792	FITTING, elbow, male, 90 deg	1	1	1
33	115764	FITTING, elbow, 90	1	1	1

Parts

Ref.	Part	Description	Quantities		
			H-30		H-XP2
			17H031	17H032	17H062
34	120804	FITTING, elbow, 1/2 npt x 1 jic	1	1	1
35	247793	HOSE, inlet, coupled	1	1	1
36	15G784	HOSE, coupled	2	2	2
37	121321	FITTING, elbow, sae x jic	1	1	1
38	15T895	HOSE, hydraulic supply	1	1	1
39	117464	CLAMP, hose, micro 1.75 max dia.	1	1	1
40	112161	SCREW, mach, hex, wshr hd	2	2	2
41	112586	SCREW, cap, hex hd	1	1	1
42	110996	NUT, hex, flange head	1	1	1
43	247816	MOTOR, 230 vac, 4.0 hp	1	1	1
43a	120710	KEY, square, .25	1	1	1
44	113802	SCREW, hex hd, flanged	4	4	4
45	15H256	PULLEY, drive, vee	1	1	1
45a	---	SCREW, cup point, 5/16-18	2	2	2
46	15H207	BRACKET, tensioner	1	1	1
47	247853	ADJUSTER, belt, tensioner	1	1	1
48	111802	SCREW, cap, hex hd	2	2	2
49	15E410	PULLEY, fan	1	1	1
50	120087	SCREW, set, 1/4 x 1/2	2	2	2
51	803889	BELT, ax46	1	1	1
52	25D458	KIT, pump, hydrl, w/iso and resin, 80			1
	25D460	KIT, pump, hydrl, w/iso and resin, 140	1	1	
53	15B456	GASKET, manifold	1	1	1
54	---	MANIFOLD, fluid	1	1	1
55	17G616	TUBE, fluid, iso, heater, in, 10kw	1		
	17G600	TUBE, fluid, iso, heater, inlet		1	1
56	17G615	TUBE, fluid, iso, heater, out, 10kw	1		
	17G601	TUBE, fluid, iso, heater, outlet		1	1
57	17G613	TUBE, fluid, res, heater, inlet, 10kw	1		
	17G603	TUBE, fluid, res, heater, inlet		1	1
58	17G614	TUBE, fluid, res, heater, outlet, 10kw	1		
	17G604	TUBE, fluid, res, heater, outlet		1	1
59	117677	FITTING, reducer #6 x #10 (jic)	1	1	1
60	117502	FITTING, reducer #5 x #8 (jic)	1	1	1
61#	24U845	TUBE, pressure relief	2	2	2
62#	24R754	CONNECTOR, power, male, 2 pin		1	1
63#	127290	CABLE, 4-pin, mf, 1.3m, molded	1	1	1
64	---	SLEEVE, wire, .50 id	3	3	3
65#	17G668	NUT, wire, gray	2	2	2
66#	295731	NUT, wire	2	2	2
67	118459	FITTING, union, swivel, 3/4"	2	2	2
68	113161	SCREW, flange, hex hd	2	2	2
69	---	GROMMET	1	1	1
70	24W204	ENCLOSURE, terminal block	1	1	1
71	17C258	ENCLOSURE, cover	1	1	1
72	172953	LABEL, designation	1	1	1
73	16X129	SCREW, mach, phillips, tooth wash	8	8	8
74	---	BUSHING, strain relief, 1/2 npt	1	1	1
75	---	NUT, strain relief, 1/2 npt	1	1	1

Ref.	Part	Description	Quantities		
			H-30		H-XP2
			17H031	17H032	17H062
76	---	BUSHING, strain relief		2	2
77	17G645	TIE, cable, fir tree	17	17	17
78	17G599	COVER, access	1	1	1
80	17D775	LABEL, safety, elec encl, lf	1	1	1
82	114269	GROMMET, rubber	1	1	1
83	---	SCREW, mach, serrated hex head; 1/4 in, #10-32	1	2	2
86	---	GROMMET, 3/4 hole x 3/32 thick	1		
87	---	GROMMET	1		
88#	24T242	CABLE, over-temp, single reactor	1		
88#	17G687	HARNESS, overtemp, reactor, dual		1	1
89#	17G684	HARNESS, heater, A, 64 in.	1		
90#	17G685	HARNESS, heater, B, 72 in.	1		
91	121309	FITTING, adapter, sae-orb x jic	2	2	2
92	24U846	BRIDGE, plug-in jumper, ut35	4	4	4
93	---	CAP, 9/16-18 jic cap-aluminum	1	1	1
94	---	CAP, 1/2-20 jic cap-aluminum	1	1	1
95	111218	CAP, tube, square	2	2	2
96	---	ENVELOPE, packing, self-adhesive	1	1	1
97	16W654	INSULATOR, foam, heater		8	8
98#	16U530	MODULE, sys srg prot	1	1	1
99#	15D906	SUPPRESSOR, round snap ferrite .260	1	1	1
100▲	16Y839	LABEL, notice, jumper	1	1	1
101	296607	TOOL, clevis pin extractor	1	1	1
102	24K207	KIT, fts, rtd, single hose	1	1	1
103	C19843	SCREW, cap, sockethead	1	1	1
104	255716	KIT, heater wire connector	1		
105	C20487	FITTING, nipple, hex	2	2	2
106	114027	WASHER, flat	8	8	8
107	---	RIVET, pop, 5/32 dia.	8	8	8
109	117284	GRILL, fan guard	1	1	1
110	296731	RESERVOIR, lube hose assembly	1	1	1
113	206995	FLUID, tsl, 1 qt.	2	2	2
118	116915	CAP, breather filler	1	1	1
119	247792	FILTER, oil, 18-23 psi bypass	1	1	1
120	15Y118	LABEL, made in the usa	1	1	1
121	106569	TAPE, electrical	1	1	1
122	125871	TIE, cable, 7.50 inch	22	22	22
123	17G649	COVER, motor	1	1	1
124	---	ENCLOSURE, electrical, 230v	1	1	1
125	16W766	COVER, control, box	1	1	1
126#	17G671	CABLE, motor, ot switch	1	1	1
127	17G644	KIT, assembly, pair, inlet	1	1	1
128	17G623	COVER, transformer	1	1	1
129	17V459	KIT, cover, hydraulic pump, clear	1	1	1
130	17G620	BRACKET, connector, hose	1	1	1
131	17G652	COVER, belt, upper	1	1	1
132	17G679	COVER, belt, lower	1	1	1
133	17G622	BRACKET, retaining, tank, shroud	1	1	1

Parts

Ref.	Part	Description	Quantities		
			H-30		H-XP2
			17H031	17H032	17H062
134	17G610	COVER, 10kw, left	1		
	●17G608	COVER, heater, right		1	1
135	17G609	COVER, 10kw, right	1		
	●17G607	COVER, heater, left		1	1
136◆	---	BAR, 55 gal chem. meas. B side	1	1	1
137◆	---	BAR, 55 gal chem. meas. A side	1	1	1
138#	17G686	HARNESS, heater, B		1	1
139	15V551	SHIELD, membrane, adm (10 pack)	1	1	1
140	24U854	MODULE, adm	1	1	1
141	16W596	LATCH, door	2	2	2
142	127296	SCREW, mchn, pnh, w/ext tooth wash	4	4	4
143	---	SPACER, nylon, 1/4 in. od	4	4	4
146	119865	SCREW, mach, hex serrated	4	4	4
148	---	LABEL, A/B	1	1	1
154#	17B856	TERMINAL BLOCK		1	1
155	C19208	WASHER, lock		1	1
156	111714	SCREW		1	1
157●	---	WASHER, flat, nylon		4	4
158	++	METER, flow, ISO	1	1	
159	++	METER, flow, RES	1	1	
160	17R703	CABLE, GCA, M12-5P, m/f, 0.3 m	1	1	
161	17Y983	CABLE, GCA, M12-5P, m/f, 0.2 m	2	2	
162	25E540	CONNECTOR, splitter	1	1	
171	17B524	HOSE, hydraulic supply	1	1	1
172▲	335005	QUICK GUIDE, shutdown	1	1	1
173▲	335005	QUICK GUIDE, startup	1	1	1

▲ Replacement safety labels, signs, tags, and cards are available at no cost.

* Parts included in Compensator Knob Assembly Kit 17G606. Purchase separately.

◆ Parts included in Drum Level Stick Kit 24M174. Purchase separately.

● Parts included with Heater Cover Kits (134, 135). Purchase separately.

See [Electrical Schematics, page 102](#).

++ Included in kit 25N930.

H-40, H-50, H-XP3

Ref.	Part	Description	Quantity								
			H-40					H-50		H-XP3	
			17H043	17H044	17H045	17H046	25R549	17H053	17H056	17H074	17H076
1	---	CART	1	1	1	1	1	1	1	1	1
2	17G646	HEATER, 7.5kw, 1 zone, rtd	2		2						
	17G648	HEATER, assy, 10.2kw, 1 zone, rtd		2		2	2	2	2	2	2
3	127277	BOLT, carriage, 1/2-13 x 3.5 l	4	4	4	4	4	4	4	4	4
4	112731	NUT, hex, flanged	4	4	4	4	4	4	4	4	4
8	115836	GUARD, finger	2	2	2	2	2	2	2	2	2
9	24U847	FAN, cooling, 120mm, 24vdc	1	1	1	1	1	1	1	1	1
10	103181	WASHER, lock ext	4	4	4	4	4	4	4	4	4
11	117683	SCREW, mach, phil pan hd	4	4	4	4	4	4	4	4	4
12	17G680	BLOCK, terminal, 6 pole	1	1	1	1	1	1	1	1	1
13	---	SCREW, 3/4 in, #6-32	2	2	2	2	2	2	2	2	2
14	247786	TRANS-FORMER, 5400va (410ft, 125m)	1	1	1	1	1	1	1	1	1
15	111800	SCREW, cap, hex hd	20	20	20	20	20	20	20	20	20
16	247826	RESERVOIR, assembly, hydraulic	1	1	1	1	1	1	1	1	1
16a	247778	HOUSING, inlet	1	1	1	1	1	1	1	1	1
16b	247771	GASKET, inlet	1	1	1	1	1	1	1	1	1
16c	247777	TUBE, inlet	1	1	1	1	1	1	1	1	1
16d	247770	TUBE, return	1	1	1	1	1	1	1	1	1
16e	25D893	FILTER, inlet	1	1	1	1	1	1	1	1	1
16f	255032	PLUG	1	1	1	1	1	1	1	1	1
16g	255021	FITTING, straight	1	1	1	1	1	1	1	1	1
17	117556	FITTING, nipple, #8 jic x 1/2 npt	1	1	1	1	1	1	1	1	1
18	17G621	BRACKET, retaining, tank	1	1	1	1	1	1	1	1	1
19	113796	SCREW, flanged, hex hd	35	35	35	35	35	35	35	35	35
20	---	ADAPTER, hydraulic gage	1	1	1	1	1	1	1	1	1
21	17G624	TUBE, gauge, pressure	1	1	1	1	1	1	1	1	1
22	15H524	ACCUMULATOR, pressure, 1/4 npt	1	1	1	1	1	1	1	1	1
23	119789	FITTING, elbow, street, 45°	1	1	1	1	1	1	1	1	1
24	112567	GAUGE, pressure, fluid	1	1	1	1	1	1	1	1	1
25	247829	COOLER, hydraulic, complete	1	1	1	1	1	1	1	1	1
26	17G612	BRACKET, mntg, pump, hyd	1	1	1	1	1	1	1	1	1

Parts

Ref.	Part	Description	Quantity								
			H-40					H-50		H-XP3	
			17H043	17H044	17H045	17H046	25R549	17H053	17H056	17H074	17H076
27	255019	PUMP, hydraulic	1	1	1	1	1	1	1	1	1
27a	129375	KEY, square	1	1	1	1	1	1	1	1	1
28*	---	KNOB, compensator	1	1	1	1	1	1	1	1	1
29*	---	KNOB, lock, compensator	1	1	1	1	1	1	1	1	1
30	15H512	LABEL, control	1	1	1	1	1	1	1	1	1
31*	---	SCREW, set, 1/4-20 sst	1	1	1	1	1	1	1	1	1
34	255020	FITTING, elbow, 1-1/16 sae x 1/2 tube	1	1	1	1	1	1	1	1	1
35	247793	HOSE, inlet, coupled	1	1	1	1	1	1	1	1	1
36	15G784	HOSE, coupled	1	1	1	1	1	1	1	1	1
37	121320	FITTING, elbow, sae x jic	1	1	1	1	1	1	1	1	1
38	15T895	HOSE, hydraulic supply	1	1	1	1	1	1	1	1	1
39	117464	CLAMP, hose, micro 1.75 max dia.	1	1	1	1	1	1	1	1	1
43	247785	MOTOR, 7.5hp, 3ph, 230V/400V	1	1	1	1	1	1	1	1	1
43a	120710	KEY, square, .25	1	1	1	1	1	1	1	1	1
44	113802	SCREW, hex hd, flanged	4	4	4	4	4	4	4	4	4
45	15H256	PULLEY, drive, vee	1	1	1	1	1	1	1	1	1
45a	---	SCREW, set, cup, 5/16-18	2	2	2	2	2	2	2	2	2
46	15H207	BRACKET, tensioner	1	1	1	1	1	1	1	1	1
47	247853	ADJUSTER, belt, tensioner	1	1	1	1	1	1	1	1	1
48	111802	SCREW, cap, hex hd	2	2	2	2	2	2	2	2	2
49	247856	PULLEY, fan	1	1	1	1	1	1	1	1	1
50	120087	SCREW, set, 1/4 x 1/2	2	2	2	2	2	2	2	2	2
51	803889	BELT, ax46	1	1	1	1	1	1	1	1	1
52	25D458	KIT, pump, hydr, w/iso and resin, 80								1	1
	25D459	KIT, pump, hydr, w/iso and resin, 120	1	1	1	1					
	25D460	KIT, pump, hydr, w/iso and resin, 140						1	1		
	25R551	KIT, pump, hydr, w/iso and resin, 120/88					1				
53	15B456	GASKET, manifold	1	1	1	1	1	1	1	1	1
54	---	MANIFOLD, fluid	1	1	1	1	1	1	1	1	1
55	17G600	TUBE, fluid, iso, heater, inlet	1	1	1	1	1	1	1	1	1
56	17G601	TUBE, fluid, iso, heater, outlet	1	1	1	1	1	1	1	1	1
57	17G603	TUBE, fluid, res, heater, inlet	1	1	1	1	1	1	1	1	1
58	17G604	TUBE, fluid, res, heater, outlet	1	1	1	1	1	1	1	1	1

Ref.	Part	Description	Quantity								
			H-40					H-50		H-XP3	
			17H043	17H044	17H045	17H046	25R549	17H053	17H056	17H074	17H076
59	117677	FITTING, reducer #6 x #10 (jic)	1	1	1	1	1	1	1	1	1
60	117502	FITTING, reducer #5 x #8 (jic)	1	1	1	1	1	1	1	1	1
61	24U845	TUBE, pressure relief	2	2	2	2	2	2	2	2	2
62#	24R754	CONNECTOR, power, male, 2 pin	1	1	1	1	1	1	1	1	1
63#	127290	CABLE, 4-pin, mf, 1.3m, molded	1	1	1	1	1	1	1	1	1
64	---	SLEEVE, wire, .50 id	3	3	3	3	3	3	3	3	3
65#	17G668	NUT, wire, gray	2	2	2	2	2	2	2	2	2
66#	295731	NUT, wire	2	2	2	2	2	2	2	2	2
67	118459	FITTING, union, swivel, 3/4 in.	2	2	2	2	2	2	2	2	2
68	113161	SCREW, flange, hex hd	2	2	2	2	2	2	2	2	2
69	---	GROMMET	1	1	1	1	1	1	1	1	1
70	24W204	ENCLOSURE, terminal block	1	1	1	1	1	1	1	1	1
71	17C258	ENCLOSURE, cover	1	1	1	1	1	1	1	1	1
72	172953	LABEL, designation	1	1	1	1	1	1	1	1	1
73	16X129	SCREW, mach, phillips, tooth wash	8	8	8	8	8	8	8	8	8
74	---	BUSHING, strain relief, 1/2 npt	1	1	1	1	1	1	1	1	1
75	---	NUT, strain relief, 1/2 npt	1	1	1	1	1	1	1	1	1
76	---	BUSHING, strain relief	2	2	2	2	2	2	2	2	2
77	17G645	TIE, cable, fir tree	17	17	17	17	17	17	17	17	17
78	17G599	COVER, access	1	1	1	1	1	1	1	1	1
80	17D776	LABEL, safety, ele encl	1	1	1	1	1	1	1	1	1
82	114269	GROMMET, rubber	1	1	1	1	1	1	1	1	1
83	---	SCREW, mach, serrated hex head, 1/4 in, #10-32	2	2	2	2	2	2	2	2	2
84	125943	NUT, serrated flange	2	2	2	2	2	2	2	2	2
85	101032	BOLT, machine	2	2	2	2	2	2	2	2	2
88#	17G687	HARNESS, overtemp, reactor, dual	1	1	1	1	1	1	1	1	1
91	121309	FITTING, adapter, sae-orb x jic	2	2	2	2	2	2	2	2	2
93	---	CAP, 9/16-18 jic cap-aluminum	1	1	1	1	1	1	1	1	1
94	---	CAP, 1/2-20 jic cap-aluminum	1	1	1	1	1	1	1	1	1
95	111218	CAP, tube, square	2	2	2	2	2	2	2	2	2
97	16W654	INSULATOR, foam, heater	8	8	8	8	8	8	8	8	8
98#	16U530	MODULE, sys srg prot	1	1	1	1	1	1	1	1	1

Parts

Ref.	Part	Description	Quantity								
			H-40					H-50		H-XP3	
			17H043	17H044	17H045	17H046	25R549	17H053	17H056	17H074	17H076
99#	15D906	SUPPRESSOR, round snap ferrite .260	1	1	1	1	1	1	1	1	1
101	296607	TOOL, clevis pin extractor	1	1	1	1	1	1	1	1	1
102	24K207	KIT, fts, rtd, single hose	1	1	1	1	1	1	1	1	1
103	C19843	SCREW, cap, sockethead	1	1	1	1	1	1	1	1	1
105	C20487	FITTING, nipple, hex	2	2	2	2	2	2	2	2	2
106	114027	WASHER, flat	8	8	8	8	8	8	8	8	8
107	---	RIVET, pop, 5/32 dia.	8	8	8	8	8	8	8	8	8
109	117284	GRILL, fan guard	1	1	1	1	1	1	1	1	1
110	296731	RESERVOIR, lube hose assy	1	1	1	1	1	1	1	1	1
113	206995	FLUID, tsl, 1 qt.	2	2	2	2	2	2	2	2	2
118	116915	CAP, breather filler	1	1	1	1	1	1	1	1	1
119	247792	FILTER, oil, 18-23 psi bypass	1	1	1	1	1	1	1	1	1
120	15Y118	LABEL, made in the usa	1	1	1	1	1	1	1	1	1
121	106569	TAPE, electrical	1	1	1	1	1	1	1	1	1
122	125871	TIE, cable, 7.50 inch	22	22	22	22	22	22	22	22	22
123	17G649	COVER, motor	1	1	1	1	1	1	1	1	1
124	---	ENCLOSURE, electrical, hf, 230v	1	1	1	1	1	1	1	1	1
125	16W766	COVER, control, box	1	1	1	1	1	1	1	1	1
126#	17G671	CABLE, motor, ot switch	1	1	1	1	1	1	1	1	1
127	17G644	KIT, assembly, pair, inlet	1	1	1	1	1	1	1	1	1
128	17G623	COVER, transformer	1	1	1	1	1	1	1	1	1
129	17V459	KIT, cover, hydraulic pump, clear	1	1	1	1	1	1	1	1	1
130	17G620	BRACKET, connector, hose	1	1	1	1	1	1	1	1	1
131	17G652	COVER, belt, upper	1	1	1	1	1	1	1	1	1
132	17G679	COVER, belt, lower	1	1	1	1	1	1	1	1	1
133	17G622	BRACKET, retaining, tank, shroud	1	1	1	1	1	1	1	1	1
134	17G608	COVER, heater, right	1	1	1	1	1	1	1	1	1
135	17G607	COVER, heater, left	1	1	1	1	1	1	1	1	1
136◆	---	BAR, 55 gal chem. meas. B side	1	1	1	1	1	1	1	1	1
137◆	---	BAR, 55 gal chem. meas. A side	1	1	1	1	1	1	1	1	1
138#	17G686	HARNESS, heater, B	1	1	1	1	1	1	1	1	1
139	15V551	SHIELD, membrane, adm (10 pack)	1	1	1	1	1	1	1	1	1

Ref.	Part	Description	Quantity								
			H-40					H-50		H-XP3	
			17H043	17H044	17H045	17H046	25R549	17H053	17H056	17H074	17H076
140	24U854	MODULE, adm	1	1	1	1	1	1	1	1	1
141	16W596	LATCH, door	2	2	2	2	2	2	2	2	2
142	127296	SCREW, mchn, pnh, w/ext tooth wash	4	4	4	4	4	4	4	4	4
143	---	SPACER, nylon, 1/4 in. od	4	4	4	4	4	4	4	4	4
144	15G782	HOSE, coupled	1	1	1	1	1	1	1	1	1
145	116793	FITTING	1	1	1	1	1	1	1	1	1
146	119865	SCREW, mach, hex serrated	4	4	4	4	4	4	4	4	4
148	---	LABEL, A/B	1	1	1	1	1	1	1	1	1
154#	17B856	TERMINAL BLOCK	1	1	1	1	1	1	1	1	1
155	C19208	WASHER, lock	1	1	1	1	1	1	1	1	1
156	111714	SCREW	1	1	1	1	1	1	1	1	1
157●	---	WASHER, flat, nylon	4	4	4	4	4	4	4	4	4
158	++	METER, flow, ISO	1	1	1	1	1	1	1		
	++	METER, flow, RES	1	1	1	1	1	1	1		
160	17R703	CABLE, GCA, M12-5P, m/f, 0.3 m	1	1	1	1	1	1	1		
161	17Y983	CABLE, GCA, M12-5P, m/f, 2.0 m	2	2	2	2	2	2	2		
162	25E540	CONNECTOR, splitter	1	1	1	1	1	1	1		
171	17B524	HOSE, hydraulic, supply	1	1	1	1	1	1	1	1	1

▲ Replacement safety labels, signs, tags, and cards are available at no cost.

* Parts included in Compensator Knob Assembly Kit 17G606. Purchase separately.

◆ Parts included in Drum Level Stick Kit 24M174. Purchase separately.

● Parts included with Heater Cover Kits (134, 135). Purchase separately.

See [Electrical Schematics, page 102](#).

++ Included in kit 25N930.

Proportioner Assembly Parts

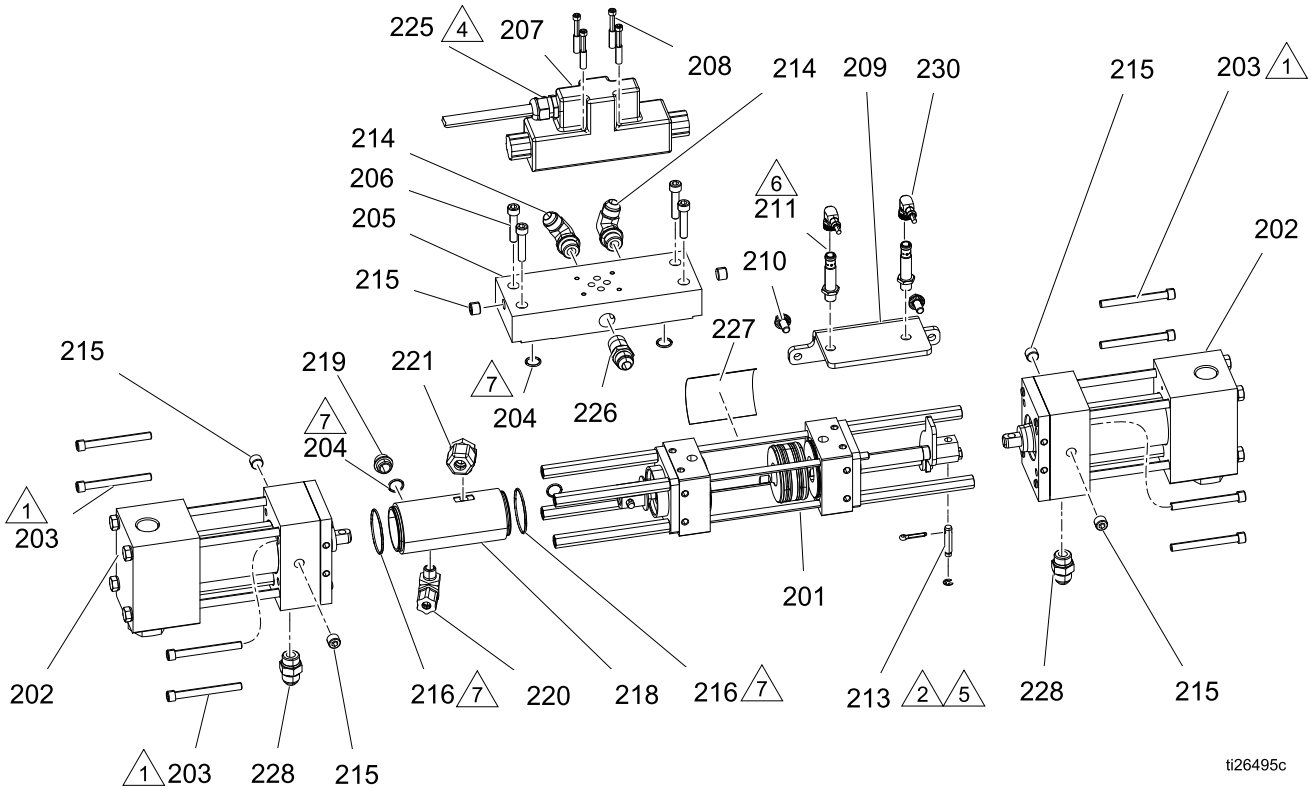

ti26495c



- | | |
|---|--|
| <p>1 Torque to 200 in-lb (22.6 N•m).</p> <p>2 Pin (213) to be clocked horizontal as shown.</p> <p>3. Apply sst pipe sealant to all non-swiveling pipe threads.</p> <p>4 Remove cover from directional valve (207) and attach solenoid harness wires (225). See Electrical Schematics, page 102.</p> | <p>5 Fully seat pin (213) with a hammer and punch.</p> <p>6 Thread in proximity switch (211) all the way until it contacts the clocking plate, then back off a 1/4-1/2 turn.</p> <p>7 Apply grease to o-rings (204, 216) before assembly.</p> |
|---|--|

Proportioner Assembly Parts

Ref.	Part	Description	Qty.	Ref.	Part	Description	Qty.
201	17G499	CYLINDER, hydraulic, with spacers	1	211	17G605	SENSOR, proximity, switch	2
202	247377	PUMP, proportioner, #120 (H-40 only, Qty. 1 for 25R549 only)	2	213	296653	PIN, clevis	2
	247576	PUMP, proportioner, #140 (H-50, H-30 only)	2	214	121312	FITTING, elbow, sae x jic	2
	247375	PUMP, proportioner, # 80 (H-XP2, H-XP3 only)	2	215	295225	PLUG, pipe, flush	6
	247577	PUMP, proportioner, #88 (Qty. 1 for 25R549 only)	1	216	106258	PACKING, o-ring	2
203	295824	SCREW, cap, sh, 5/16 x 3	8	218	---	CYLINDER, lube (included in kit 261863)	1
204	112793	PACKING, o-ring	3	219	295829	FITTING, plug, 3/8 mpt x .343 lg	1
205	17G531	MANIFOLD, hydraulic	1	220	295826	FITTING, elbow, 90, 1/4 mpt x 3/8 in.	1
206	113467	SCREW, cap, socket hd	4	221	295397	FITTING, elbow, 3/8 mpt x 1/2 in.	1
207	120299	VALVE, directional, hydraulic	1	225	17G690	HARNESS, valve, solenoid, hr2	1
208	C19986	SCREW, cap, socket, hd	4	226	121319	FITTING, adapter, npt x jic	1
209	---	BRACKET, proximity switch	1	228	121309	FITTING, adapter, sae-orb x jic	2
210	111800	SCREW, cap, hex hd	2	230	17G669	CABLE, gca, m12 (m), m12(f/f), 2 m, s/r/r	1

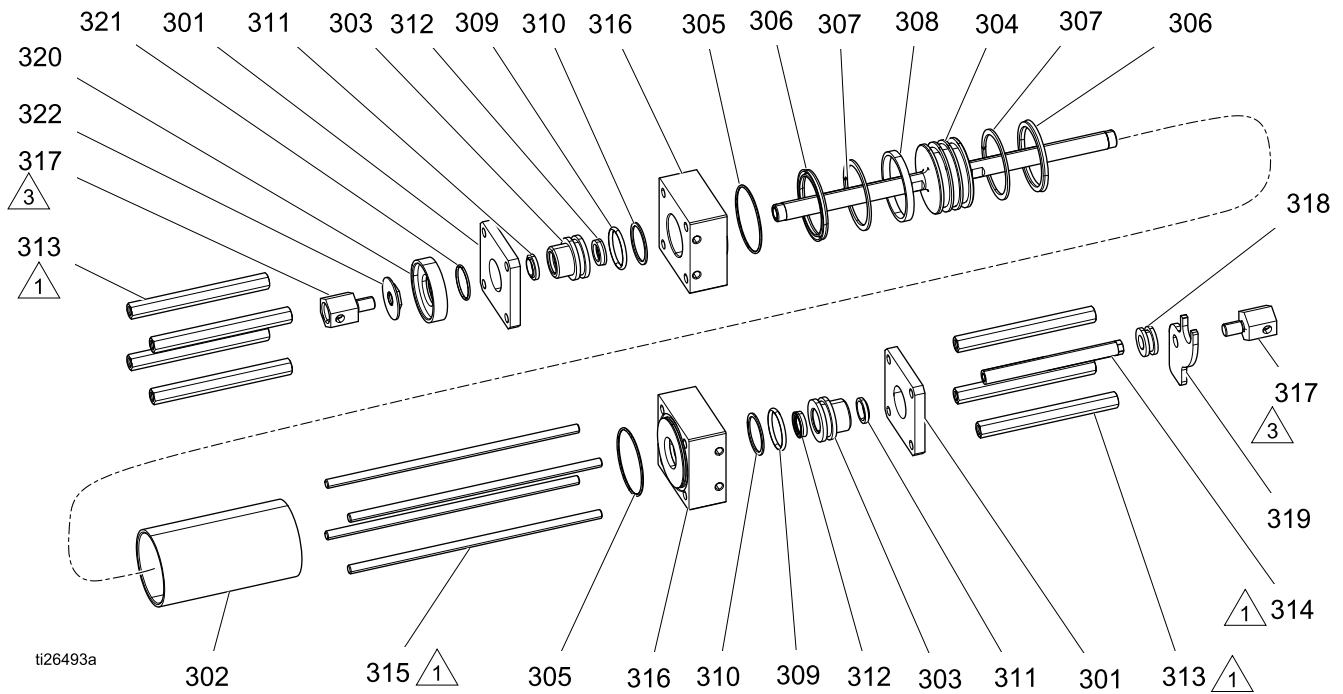
Hydraulic Cylinder Parts, 17G499



-  Torque spacers (313, 314) and rod (315) to 200 in-lb (22.5 N•m).
-  Torque to 40 +/- 5 ft-lb (345 +/- 54 N•m)
- 4. Apply grease to all soft parts before assembly.



Ref.	Part	Description	Qty.	Ref.	Part	Description	Qty.
301	295029	PLATE, retainer	2	313	295032	SPACER, proportioner	7
302	295030	CYLINDER	1	314	261502	SPACER, reversing switch	1
303*	295031	BUSHING, rod	2	315	295034	ROD, tie	4
304	296642	PISTON, cylinder, hydraulic	1	316	295035	BLOCK, port	2
305*	295640	O-RING	2	317	261864	CLEVIS, hex	2
306*	295641	SEAL, u-cup	2	318	17G527	BUSHING, clocking	1
307*	295642	RING, back-up	2	319	17G529	PLATE, clocking, driver	1
308*	296643	RING, wear	1	320	---	ADAPTER, lube, cylinder (included in kit 261863)	1
309*	158776	PACKING, o-ring	2	321	177156	PACKING, o-ring	1
310*	295644	RING, back-up	2	322	295852	NUT, jam, baffle	1
311*	295645	WIPER, rod	2				
312*	295646	SEAL, shaft	2				

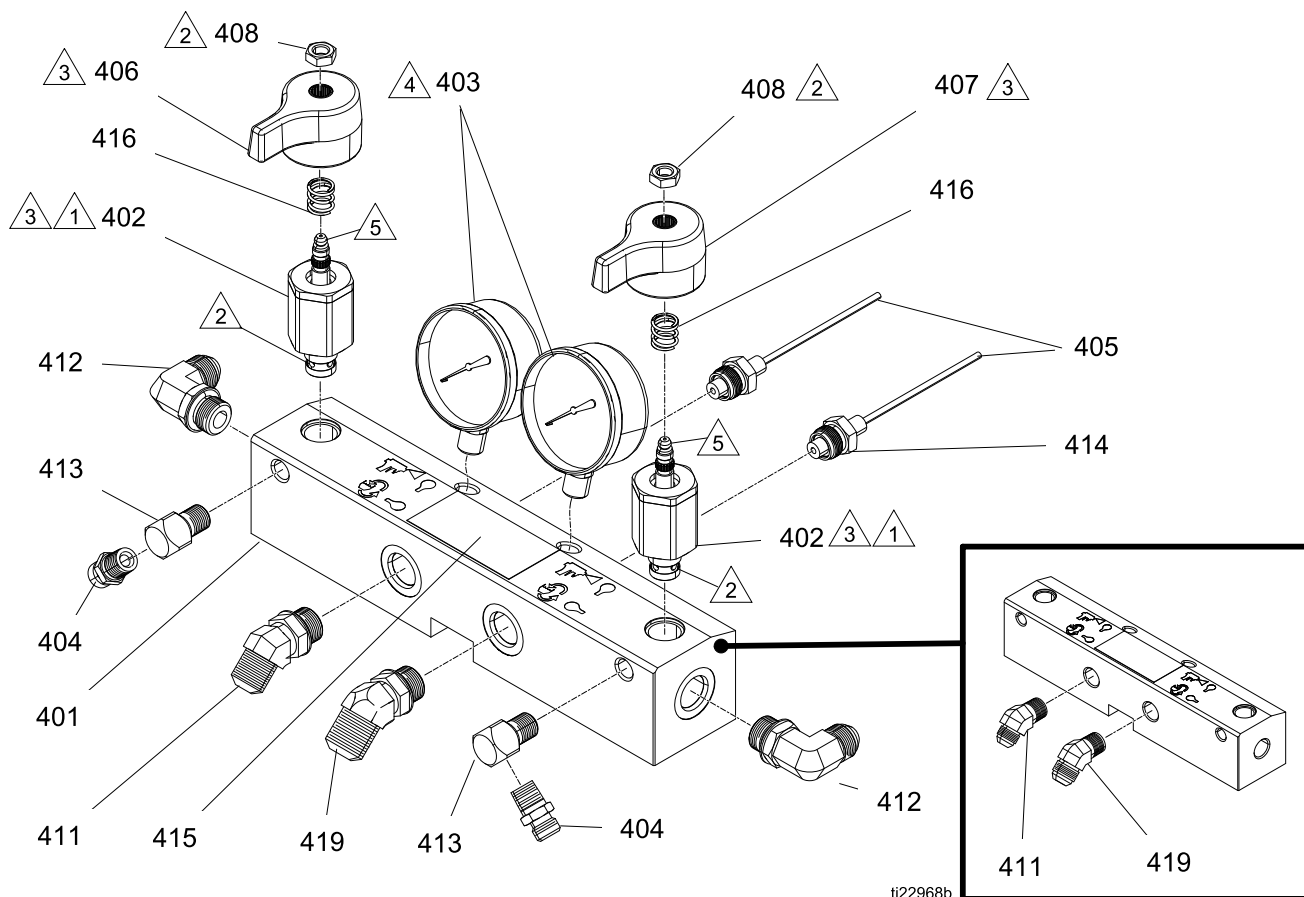

* Parts are also included in Hydraulic Cylinder Repair Kit 296785. Purchase separately.

Fluid Manifold 24U844



ti22968b

-  1 Torque to 355–395 in.-lbs (40–44.6 N•m)
-  2 Apply sealant (113500) to threads.
-  3 Valve must be closed with handle position as shown on drawing.

-  4 Apply PTFE tape and thread sealant to gauge threads.
-  5 Apply grease on valve.
- ** Apply PTFE tape or thread sealant to tapered threads.

24U844, Fluid Manifold

Ref.	Part	Description	Qty.	Ref.	Part	Description	Qty.
401†	255228	MANIFOLD, fluid	1	416	150829	SPRING, compression	2
402◇	247824	KIT, valve, cartridge, drain	2	419‡	17Y235	FITTING, 3/4 ORB x #10 JIC	1
402a◇	158674	O-RING, BUNA-N	1		117557	FITTING, 1/2 NPT x #10 JIC	1
402b◇	247779	SEAL, seat, valve	1				
403	102814	GAUGE, press, fluid	2				
404	162453	FITTING, 1/4 NPSM X 1/4 NPT	2	▲	<i>Replacement safety labels, signs, tags, and cards are available at no cost.</i>		
405	15M669	SENSOR, pressure, fluid outlet	2				
406	247788	HANDLE, red	1	◇	<i>Part included in the following complete valve kits:</i>		
407	247789	HANDLE, blue	1		<i>ISO Valve Kit (left/red) handle 255149.</i>		
408	112309	NUT, hex, jam	2		<i>Resin Valve Kit (right/blue handle) 255150.</i>		
411‡	17Y236	FITTING, 3/4 ORB x #8 JIC	1		<i>Valve Set Kit (both handles and grease gun) 255148.</i>		
	117556	FITTING, 1/2 NPT x #8 JIC	1				
412	121312	FITTING, elbow, 3/4 SAE x 1/2 JIC	1	†	<i>Part includes replacement ORB fittings (part 411 and 419).</i>		
413	100840	FITTING, elbow, street	2				
414	111457	O-RING, PTFE	2	‡	<i>To order a replacement part, verify the type of fitting used with your fluid manifold (1/2 NPT or 3/4 ORB fitting).</i>		
415▲	189285	LABEL, caution	1				

Heater Parts

17G646, 7.5kw Single Zone Heater

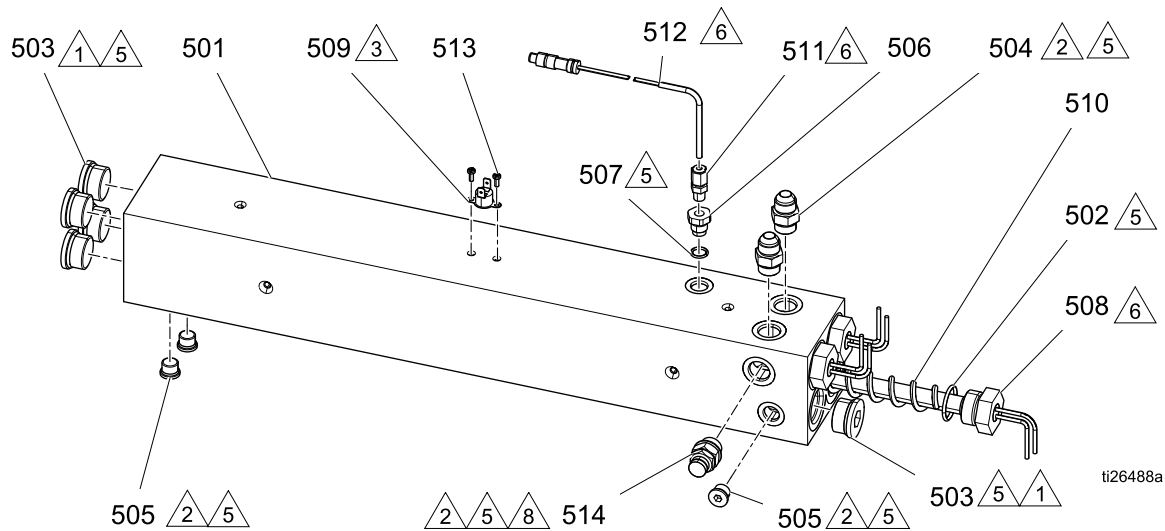

17G648, 10.2 kw Single Zone Heater

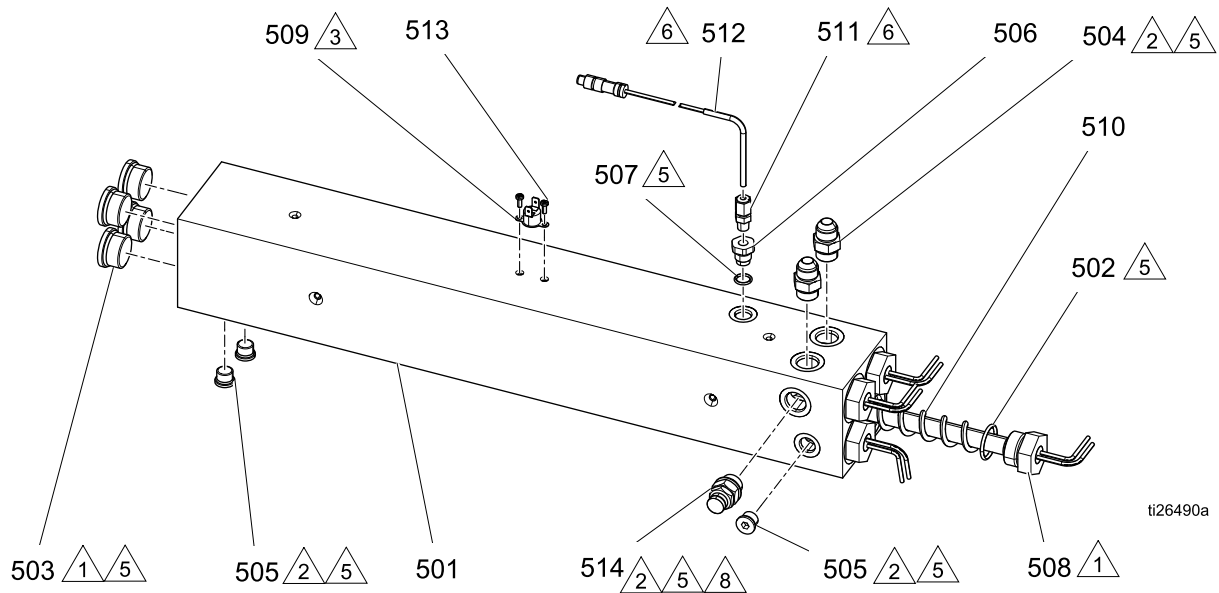

1 Torque to 120 ft-lb (163 N•m).

2 Torque to 23 ft-lb (31 N•m).

3 Apply thermal paste.

4. Apply pipe sealant and PTFE tape to all non-swiveling threads and threads without o-rings.

5 Apply lithium grease lubricant to o-rings before assembling in block (501).

6 Orientate sensor as shown. Insert probe until it bottoms on heating element. Tighten ferrule on sensor probe one turn past finger tight or 180 in-lb (20.3 N•m).

8 Orient rupture disc housing (514) with exhaust hole pointing away from fitting (508).

17G647, 10.2 kW Dual Zone Heater

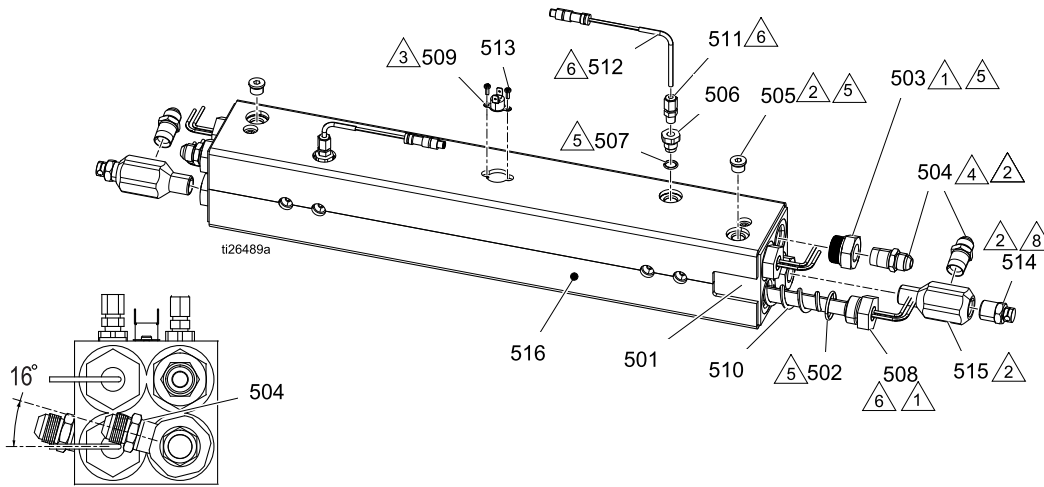

- 1** Torque to 120 ft-lb (163 N•m).
- 2** Torque to 23 ft-lb (31 N•m).
- 3** Apply thermal paste.
- 4.** Apply pipe sealant and PTFE tape to all non-swiveling threads and threads without o-rings.
- 5** Apply lithium grease lubricant to o-rings before assembling in block (501).
- 6** Orientate sensor as shown. Insert probe until it bottoms on heating element. Tighten ferrule on sensor probe one turn past finger tight or 180 in-lb (20.3 N•m).
- 8** Orient rupture disc housing (514) with exhaust hole pointing away from fitting (505).

Ref.	Part	Description	Quantities		
			17G646	17G648	17G647
501	- - -	HEATER, housing	1	1	1
502	124132	O-RING	3	4	4
503	15H305	FITTING, plug hollow hex 1-3/16 sae	5	4	
	15H302	FITTING, 1/2-14 npt(f) x 3/16-12 UN-2A			4
504	121309	FITTING, adapter, sae-orb x jic	2	2	
	121319	FITTING, adapter, npt x JIC			4
505	15H304	FITTING, plug 9/16 sae	3	3	2
506	15H306	ADAPTER, thermocouple, 9/16 x 1/8	1	1	2
507	120336	O-RING, packing	1	1	2
508	16A110	HEATER, immersion, (2550w, 230v)	3	4	4
509	15B137	SWITCH, over temperature	1	1	1
510	15B135	MIXER, immersion heater	3	4	4
511	123325	FITTING, compression, 1/8npt, ss	1	1	2
512	124262	SENSOR, rtd, 1kohm, 90deg, 4pin, tip	1	1	2
513	- - -	SCREW, mach, pnh, .375 in, #6-32	2	2	2
514	247520	HOUSING, rupture disc	1	1	
	248187	HOUSING, rupture disc			2
515	15R873	FITTING, tee, 1/2-14 npt(m) x 1/2-14 npt(f) x 1/2-14 npt(f)			1
516	15M177	INSULATOR, foam, heater			1

Electrical Enclosure

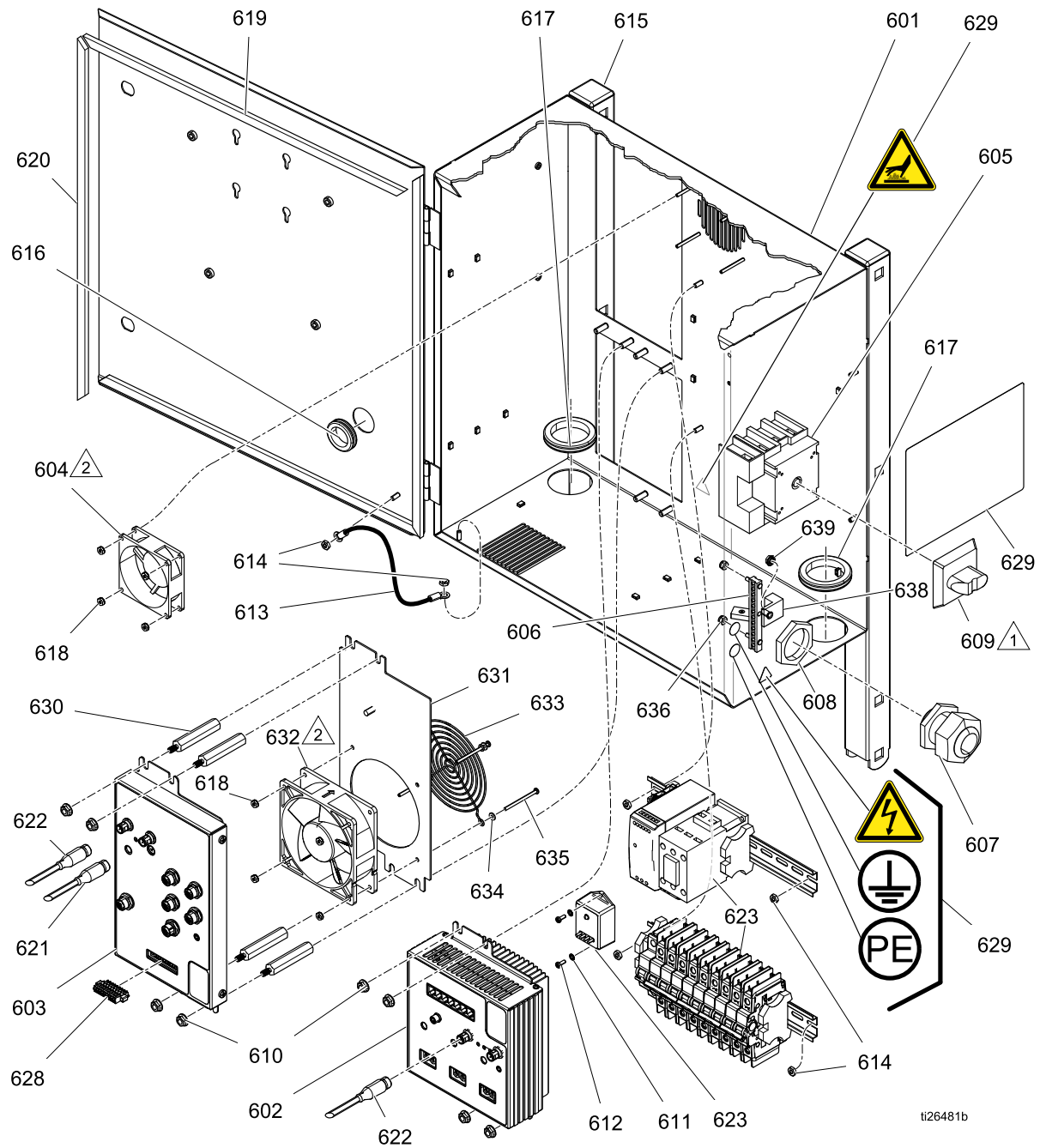

t126481b

- 1 Install disconnect switch (609) so that up is ON and left is OFF.
- 2 Mount fans (604, 632) with arrows pointing towards the panel.

Parts

Ref.	Part	Description	Quantity		
			H-30, H-XP2	H-40, H-50, H-XP3 (230V)	H-40, H-50, H-XP3 (400V)
601	- - -	ENCLOSURE, electrical	1	1	1
602	24U855	MODULE, TCM	1	1	1
603	24Y263	MODULE, HCM	1	1	1
604	24U848	FAN, cooling, 80mm, 24vdc	1	1	1
605	24R736	SWITCH, disconnect, door mounted	1	1	1
606	17G653	BAR, ground, kit	1	1	1
607	255047	BUSHING, strain relief, m40 thread	1	1	1
608	255048	NUT, strain relief, m40 thread	1	1	1
609	123967	KNOB, operator disconnect	1	1	1
610	115942	NUT, hex, flange head	8	8	8
611	103181	WASHER, lock ext	2	2	2
612	- - -	SCREW, mach, pnh, .375 in, #6-32	2	2	2
613	194337	WIRE, grounding, door	1	1	1
614	113505	NUT, keps, hex hd	6	6	6
615	111218	CAP, tube, square	2	2	2
616	114269	GROMMET, rubber	1	1	1
617	- - -	GROMMET, 1.75 id x .12 groove	2	2	2
618	127278	NUT, keps, hex	4	8	8
619	16W925	GASKET, enclosure, foam	2	2	2
620	16W926	GASKET, enclosure, foam	2	2	2
621*	24R735	CABLE, can power, m12 fem, pigtail	1	1	1
622*	127068	CABLE, can, female/female 1.0m	2	2	2
623*	- - -	KIT, din rail and harness module	1		
	- - -	KIT, din rail and harness module, 400V			1
	- - -	KIT, din rail and harness module, 230V		1	
627*	17G689	HARNESS, hcm ground	1	1	1
628	17G670	CONNECTOR, 9 pin, sprg cg, retain screw	1	1	1
629s	16X049	LABEL, safety	1	1	1
630	17G625	SPACER, hex, mf, 1/4-20, 2.5 in.		4	4
631	- - -	BRACKET, fan, adapter, hcm		1	1
632	17G650	FAN, 120 mm, 24 vdc, 158 cfm		1	1
633	115836	GUARD, finger		1	1
634	151395	WASHER, flat		4	4
635	117723	SCREW, mach, x rec, panhd		4	4
636	109466	NUT, lock, hex	2	2	2
637	17D776	LABEL, electrical enclosure; not shown		1	1
	17D775	LABEL, electrical enclosure; not shown	1		
638	117666	TERMINAL, ground	1	1	1
639	115942	NUT, hex, flange head	1	1	1
638	117666	TERMINAL, ground	1	1	1
639	115942	NUT, hex, flange head	1	1	1

▲ Replacement safety labels, signs, tags, and cards are available at no cost.

* See *Electrical Schematics*, page 102.

System Din Rail and Harness Module Kits

H-30, H-XP2 Din Rail and Harness Module Kit

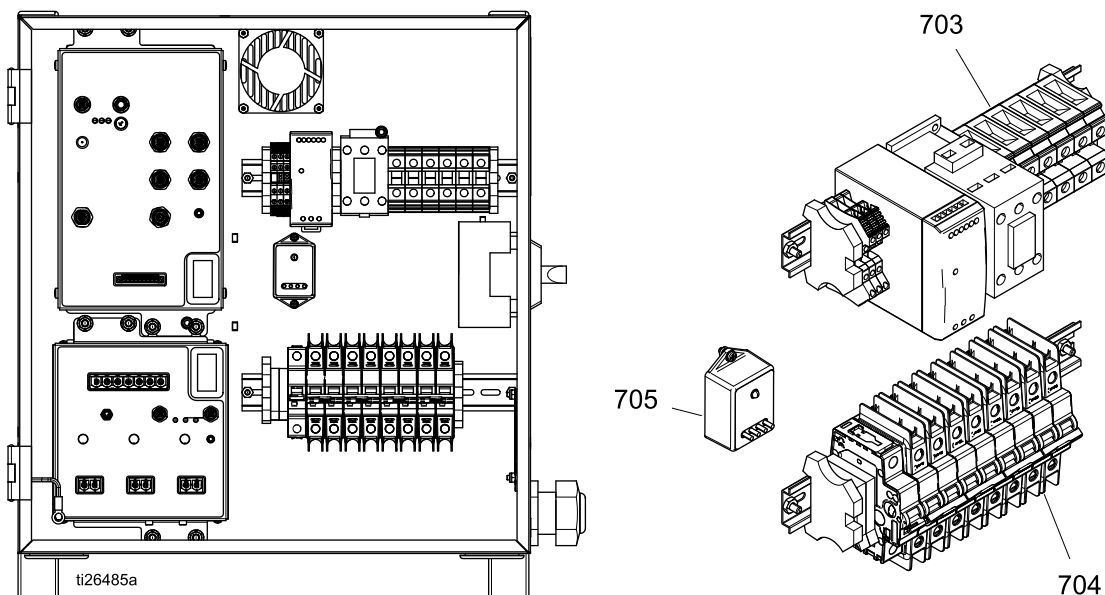

Ref.	Part	Description	Qty.
701*	17G691	HARNESS, breaker module	1
702*	17G692	HARNESS, hose out	1
703◇	- - -	MODULE, din rail, power supply	1
704●	- - -	MODULE, din rail, circuit breakers	1
705	16U530	MODULE, system surge protector	1
709*	17G693	HARNESS, motor, low flow, 4 HP	1

* See *Electrical Schematics, page 102.*

◇ See *H-30, H-XP2 Power Supply and Terminal Block Module, page 96.*

● See *H-30, H-XP2 System Circuit Breaker Module, page 96.*

H-30, H-XP2 Power Supply and Terminal Block Module

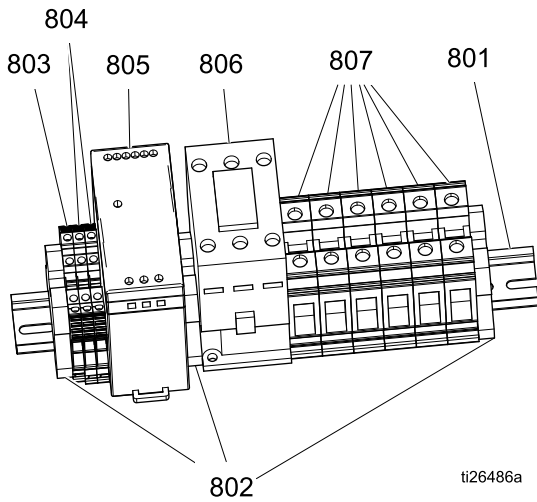

Ref.	Part	Description	Qty.
801	---	RAIL, mount, 18 mm slot	1
802	255045	BLOCK, clamp end	3
803	24R722	BLOCK, terminal PE, quad, AB	1
804	24R723	BLOCK, terminal, quad M4, AB	2
805	126453	POWER SUPPLY, 24V	1
806	255022	RELAY, contactor, 65A, 3p	1
807	24R724	BLOCK, terminal, UT35	6

H-30, H-XP2 System Circuit Breaker Module

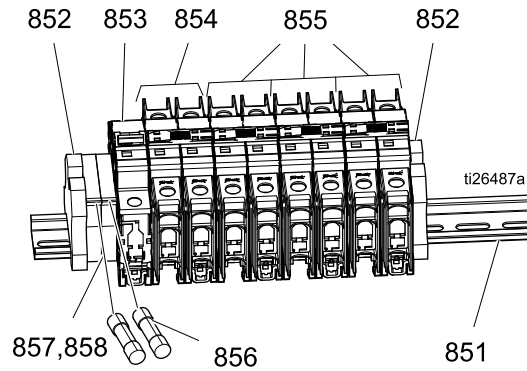

Ref.	Part	Description	Qty.
851	---	RAIL, mount, 18 mm slot	1
852	255045	BLOCK, clamp end	2
853	17A319	CIRCUIT, breaker, 1P, 50A, UL1077, AB	1
854	17A314	CIRCUIT, breaker, 2P, 20A, UL489, AB	1
855	17A317	CIRCUIT, breaker, 2P, 40A, UL489, AB	3
856	17G667	FUSE, 2.5 amp, 250V, time-lag	2
857	255043	HOLDER, fuse terminal block, 5 x 20 mm	2
858	---	COVER, end, fuse block	1

H-40, H-50, H-XP3 Din Rail and Harness Module Kits

H-40, H-50, H-XP3 (200–240V)

H-40, H-50, H-XP3 (350–415V)

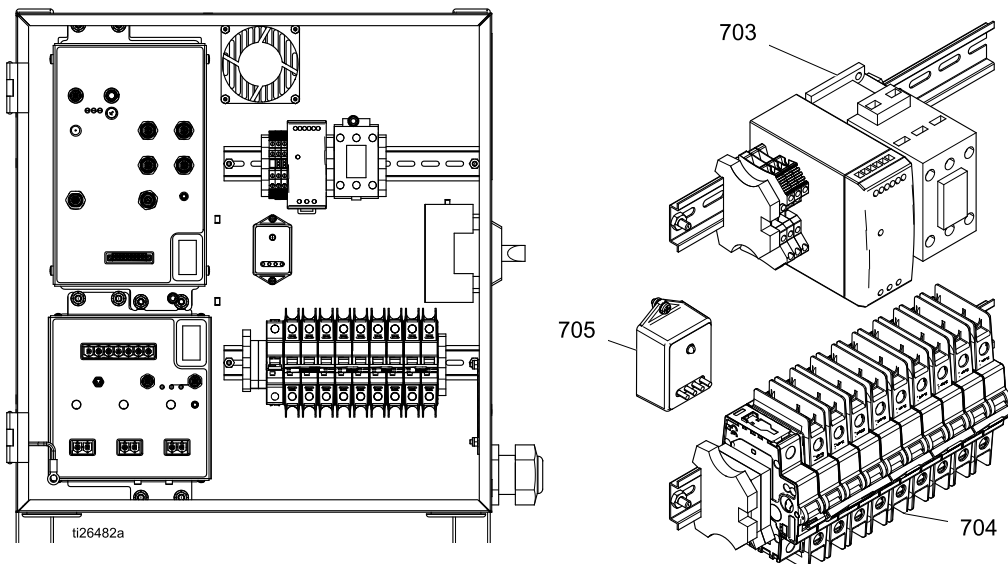

Ref.	Part	Description	Quantity	
			200–240 V	350–415 V
701*	17G691	HARNESS, breaker module	1	1
702*	17G692	HARNESS, hose out	1	1
703★	- - -	MODULE, din rail, power supply	1	1
704●	- - -	MODULE, din rail, circuit breakers	1	1
705	16U530	MODULE, system surge protector	1	1
709*	17G688	HARNESS, motor, 7.5 HP	1	1

* See *Electrical Schematics, page 102.*

◇ See *H-30, H-XP2 Power Supply and Terminal Block Module, page 96.*

● See *H-30, H-XP2 System Circuit Breaker Module, page 96.*

Inlet Sensor Kit

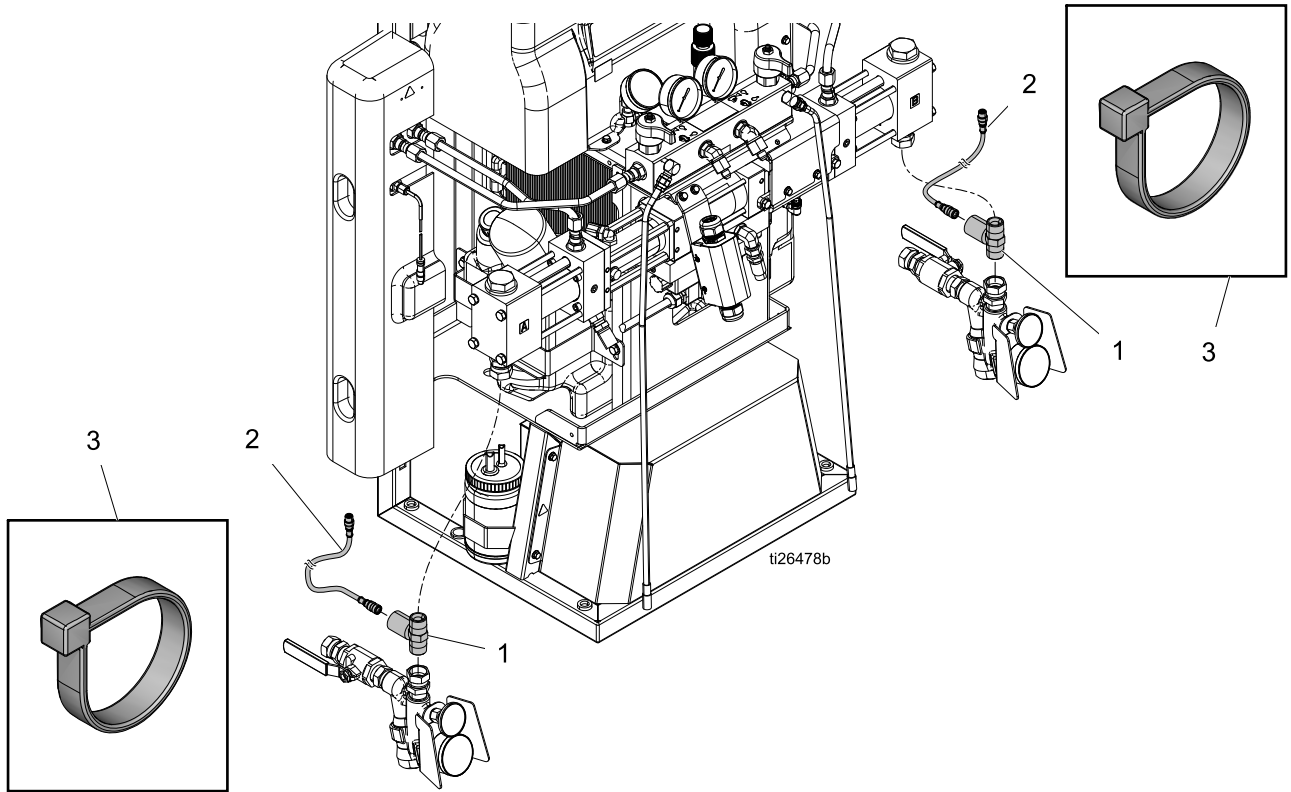

17F837

Ref.	Part	Description	Qty.
1	----	ASSEMBLY, transducer; includes 1a and 1b	2
1a	624545	FITTING, nipple, pipe	2
1b	24U851	TRANSDUCER, includes foam	2
2	16W130	CABLE, M12 5p, f x m, 2.0 m	2
3	125871	TIE, cable, 7.5 in.	8

Fluid Inlet Kits

24U320, Standard
25N920, Elite

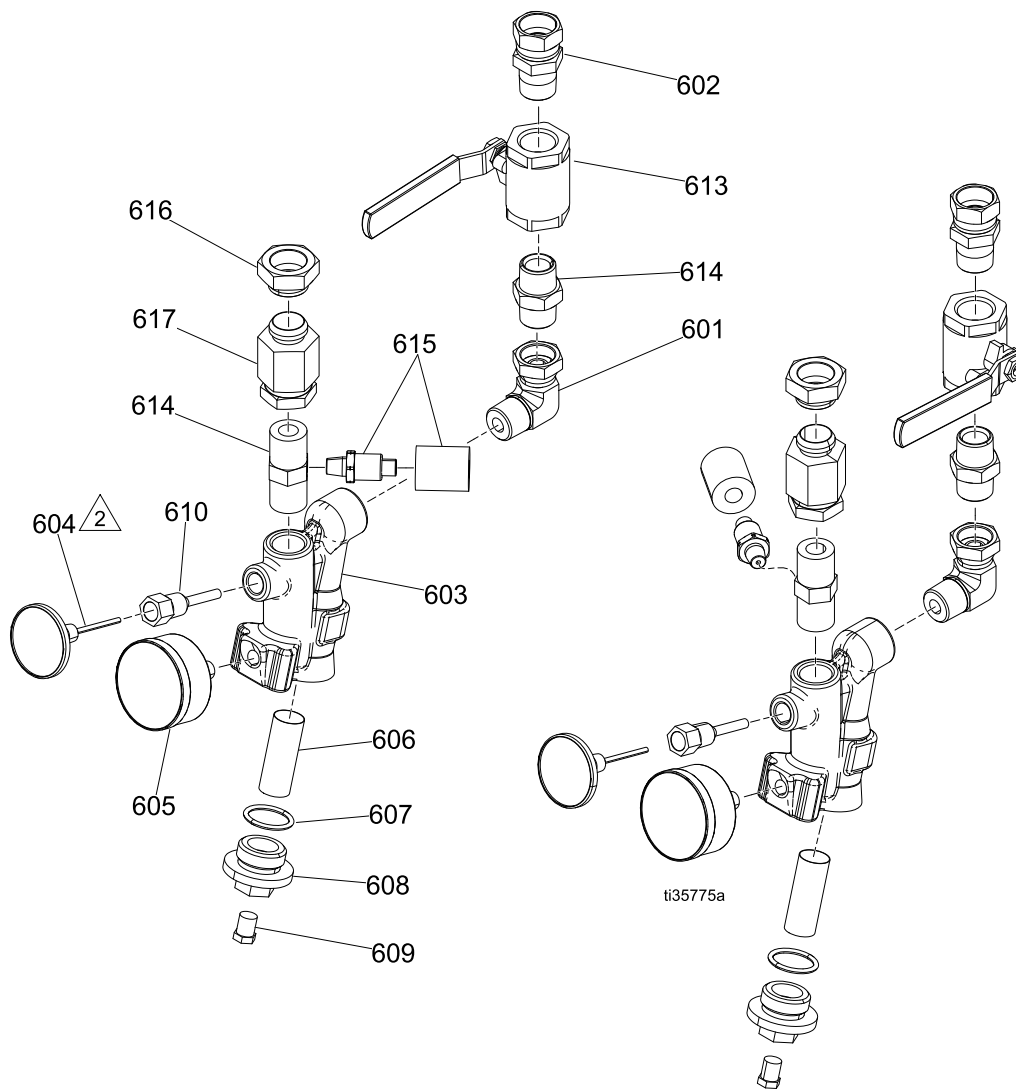

Apply sealant to all tapered pipe threads. Apply sealant to female threads. Apply to at least the first four threads and approximately 1/4 turn wide.



Apply thermal paste to the stem of dial before assembling into housing.

Parts

Ref.	Part	Description	Quantity	
			24U320	25N920
601	160327	FITTING, union adapter, 90°	2	2
602	118459	FITTING, union, swivel, 3/4 in.	2	2
603‡	247503	MANIFOLD, strainer, inlet	2	2
604	24U852	THERMOMETER, dial	2	2
605	24U853	GAUGE, press, fluid	2	2
606†	- - -	FILTER, replacement	2	2
607†‡	128061	PACKING, o-ring	2	2
608‡	16V879	CAP, filter	2	2
609‡	555808	PLUG, 1/4mp w/ hex hd	2	2
610	15D757	HOUSING, thermometer, Viscon HP	2	2
613	109077	VALVE, ball 3/4 npt	1	2
614	C20487	FITTING, nipple, hex	2	2
615	24U851	TRANSDUCER, pressure, temperature (includes foam)		2
616	158586	FITTING, bushing		2
617	158383	FITTING, union adapter		2
618	624545	FITTING, tee 3/4m run x 1/4f		2

* *Optional 80 mesh filter 255082 (2 pack)*

† *Included in 24V020 Inlet Filter and Seal Kit, 20 mesh (2 pack).*

‡ *Included in 247503 Manifold Repair Kit.*

H-40, H-50, H-XP3 Power Supply and Terminal Block Module

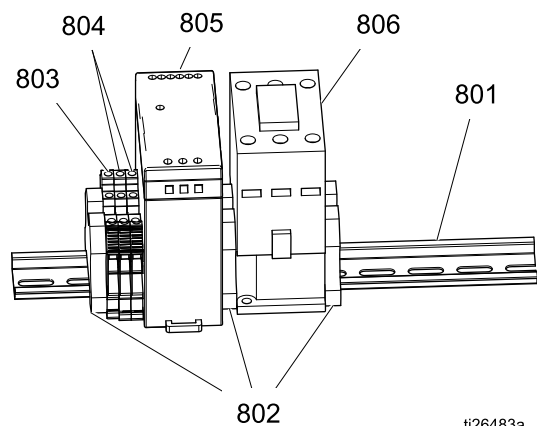

ti26483a

Ref.	Part	Description	Qty.
801	---	RAIL, mount, 18 mm slot	1
802	255045	BLOCK, clamp end	3
803	24R722	BLOCK, terminal PE, quad, AB	1
804	24R723	BLOCK, terminal, quad M4, AB	2
805	126453	POWER SUPPLY, 24V	1
806	255022	RELAY, contactor, 65A, 3p	1

H-40, H-50, H-XP3 System Circuit Breaker Module

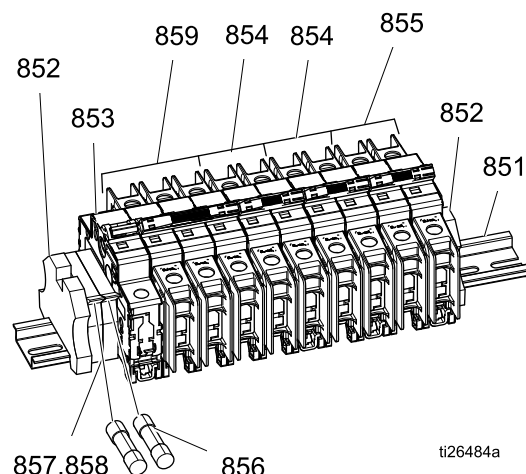

ti26484a

Ref.	Part	Description	Qty.
851	---	RAIL, mount, 18 mm slot	1
852	255045	BLOCK, clamp end	2
853	17A319	CIRCUIT, breaker, 1P, 50A, UL1077, AB	1
854	17G723	CIRCUIT, breaker, 2P, 60A, UL489, AB	2
855	17A317	CIRCUIT, breaker, 2P, 40A, UL489, AB	1
856	17G667	FUSE, 2.5 amp, 250V, time-lag	2
857	255043	HOLDER, fuse terminal block, 5 x 20 mm	2
858	---	COVER, end, fuse block	1
859	17G724	CIRCUIT, breaker, 3P, 20A, UL489, AB	1

Electrical Schematics

H-30, H-XP2 DIN Assembly Schematic

See [System Din Rail and Harness Module Kits, page 95](#), for additional part numbers.

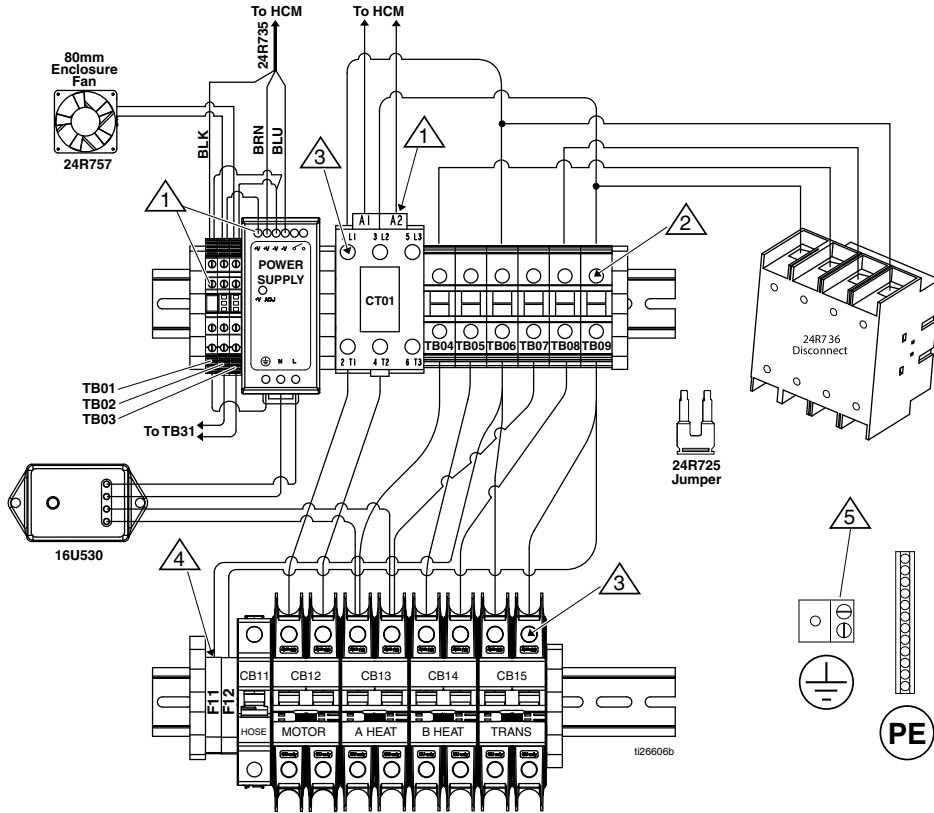

INCOMING POWER DIAGRAM

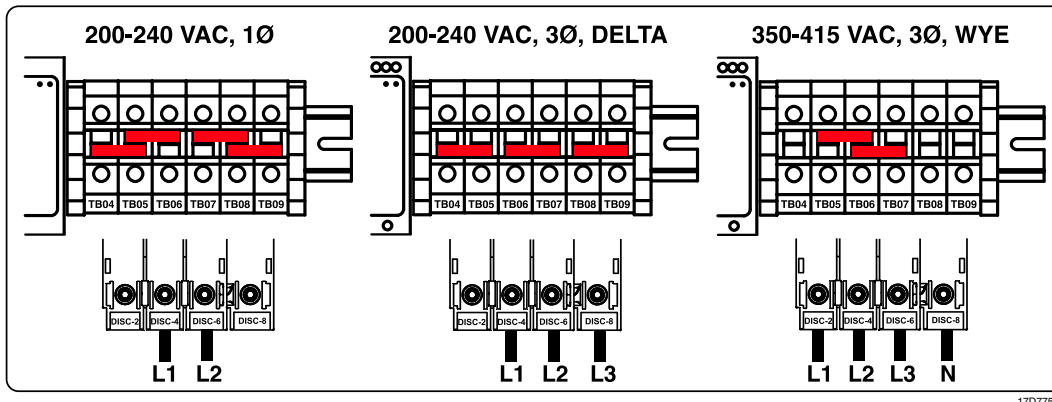

17D775

- 1 Torque to 6–8 in-lb (0.7– 0.9 N•m)
- 2 Torque to 28–33 in-lb (3.1– 3.8 N•m)
- 3 Torque to 23–26 in-lb (2.6–2.9 N•m)
- 4 Torque to 3–5 in-lb (0.3–0.6 N•m)
- 5 Connect customer-supplied ground wire.

H-40, H-50, H-XP3 DIN Assembly Schematics (200–240V)

See [System Din Rail and Harness Module Kits](#), page 95, for additional part numbers.

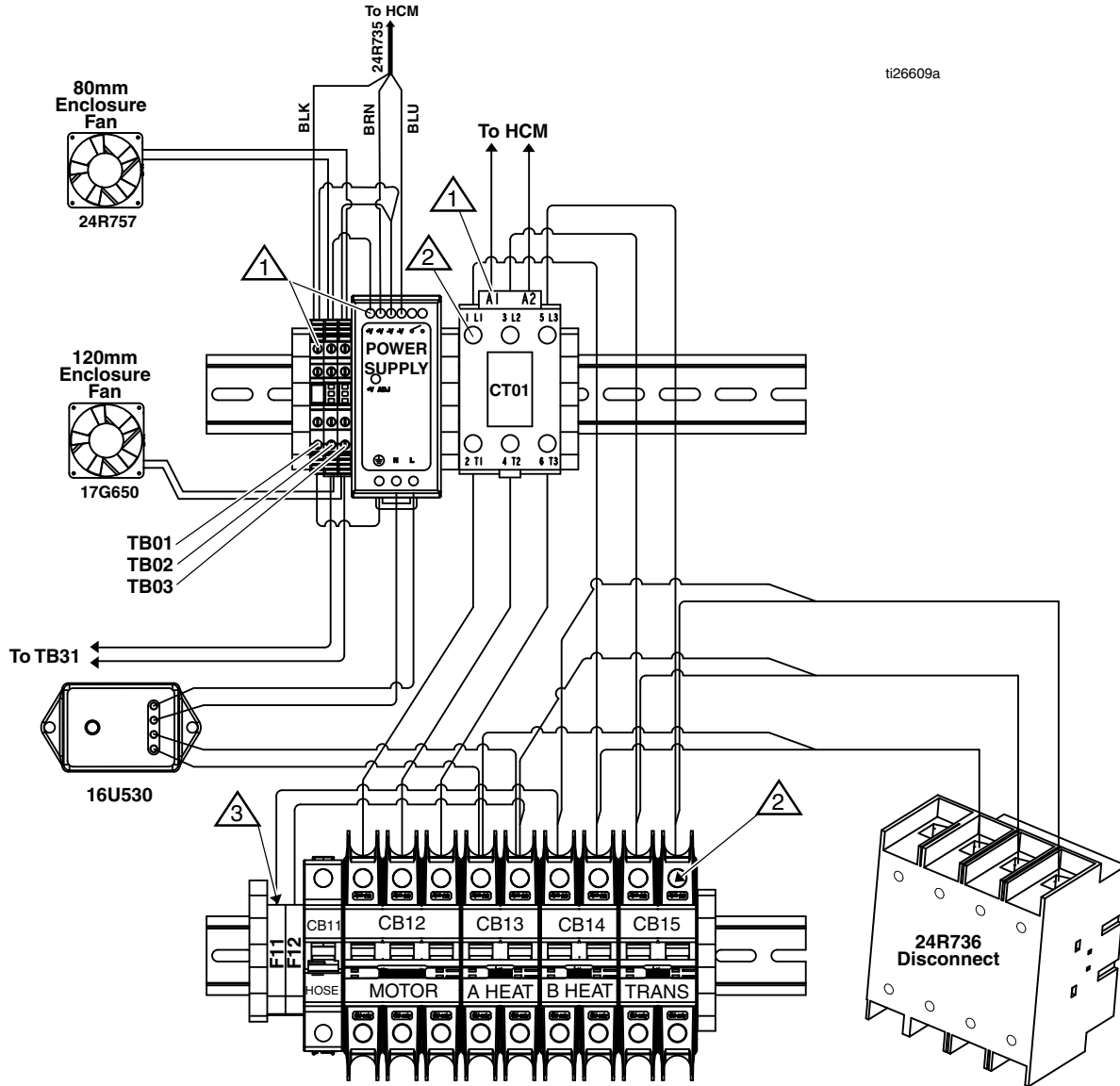

- 1 Torque to 6–8 in-lb (0.7– 0.9 N•m).
- 2 Torque to 23–26 in-lb (2.6–2.9 N•m).
- 3 Torque to 3–5 in-lb (0.3– 0.6 N•m).

H-40, H-50, H-XP3 DIN Assembly Schematics (350–415V)

See [System Din Rail and Harness Module Kits](#), page 95, for additional part numbers.

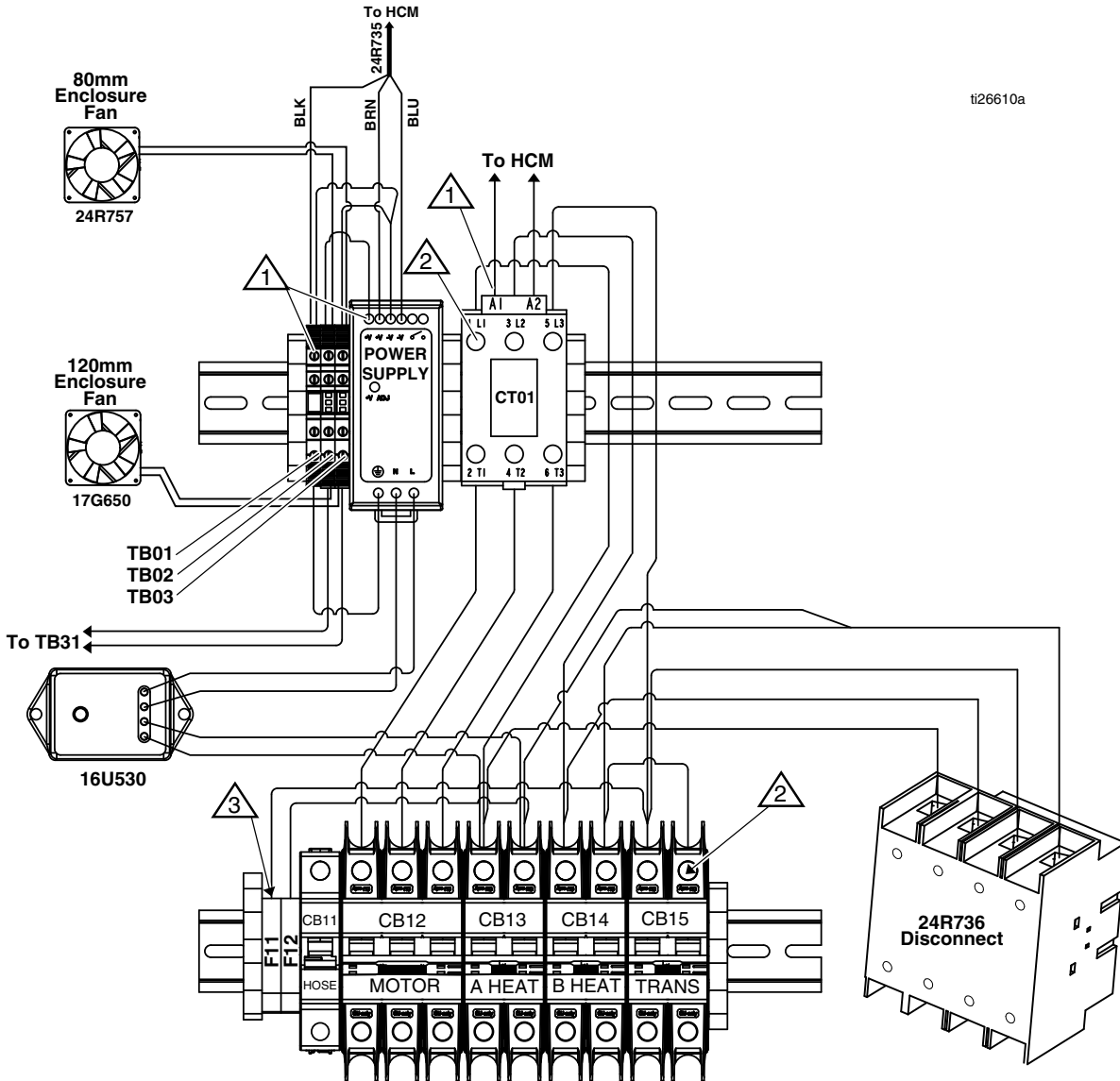

ti26610a

- 1 Torque to 6–8 in-lb (0.7– 0.9 N•m).
- 2 Torque to 23–26 in-lb (2.6–2.9 N•m).
- 3 Torque to 3–5 in-lb (0.3–0.6 N•m).

HCM Schematic

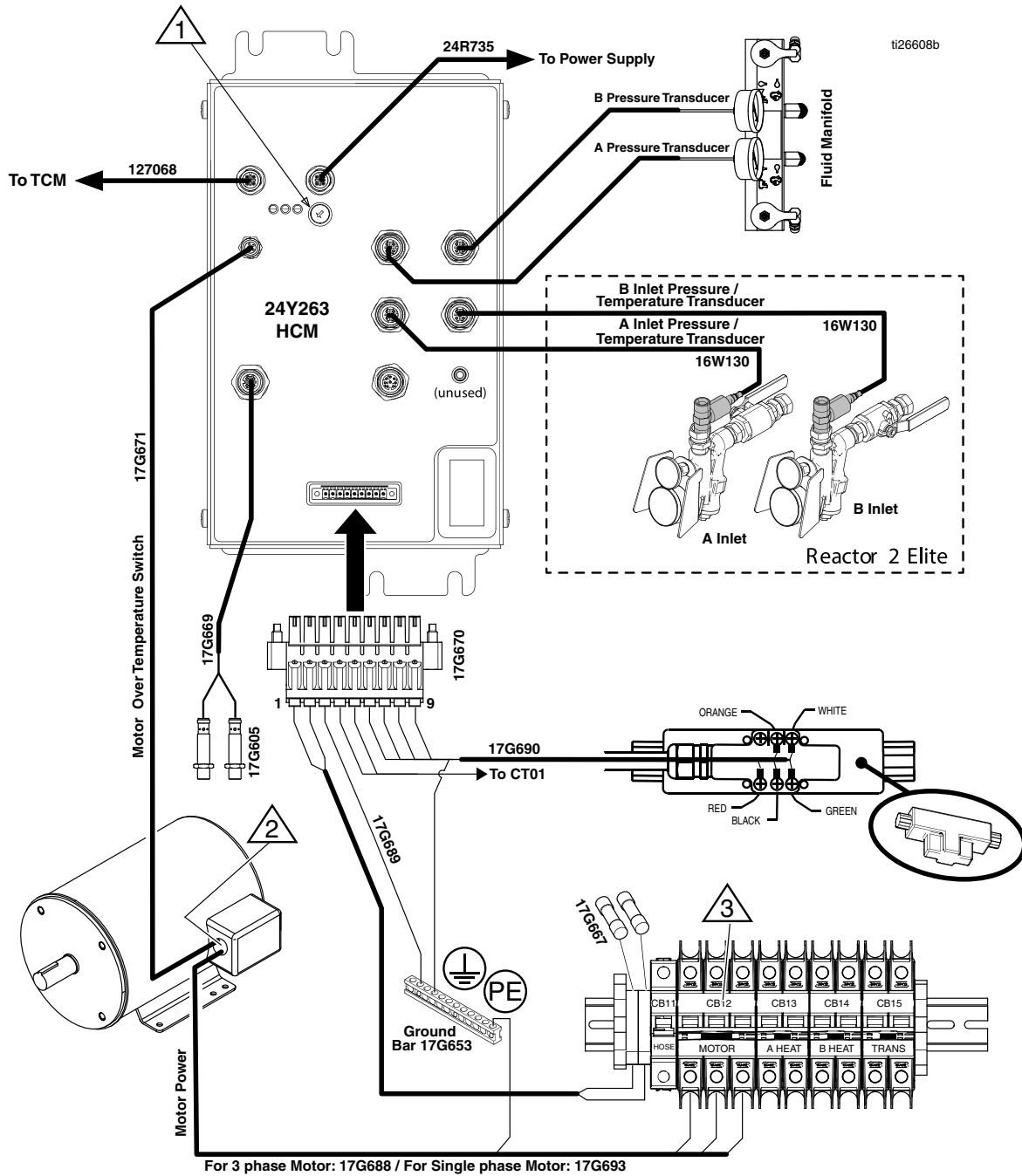

- 1 See [Replace HCM, page 70](#) for setting the rotary switch position.
- 2 Connect the blue and brown wires to the motor over-temperature wires inside the motor junction box.
- 3 Three pole version of CB12 shown. H-30 and H-XP2 uses a two pole version of CB12.

TCM Schematic

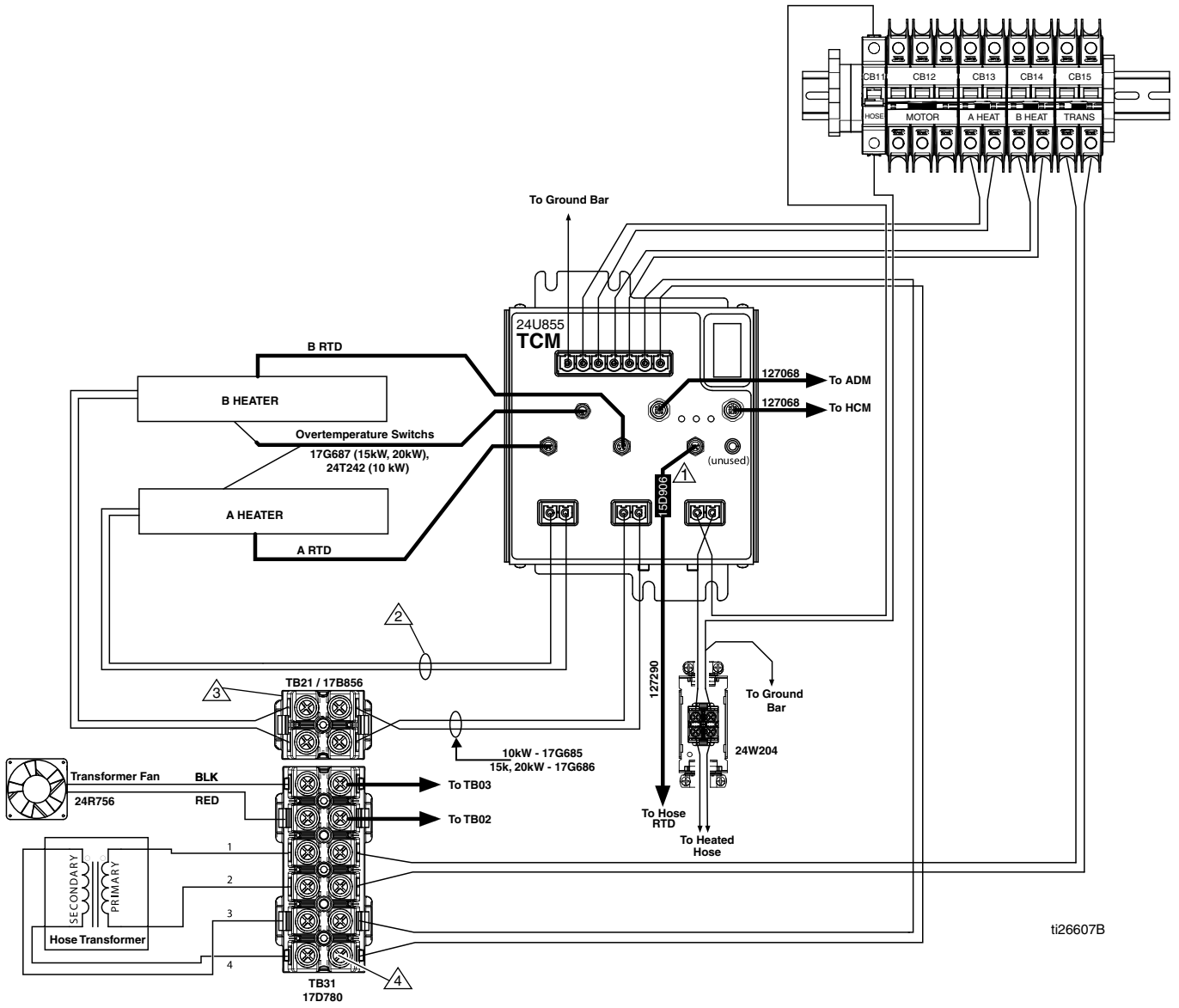

1 Locate near TCM.

2 Direct connect heater elements to TCM for 15kW and 20kW systems. Harness 17G684 and splice connectors (255716) used for 10kW systems.

3 Terminal block TB21 only used in 15kW and 20kW systems. Use splice connectors 255716 for 10kW systems.

4 Torque to 35-45 in.-lb. (4-5 N•m).

Hydraulic Reactor 2 Repair Spare Parts Reference

Recommended Common Spare Parts

Ref.	Part	Description	Part of Assembly
202	261854	H-XP2 and H-XP3 Cylinder Seal Kit	Pump
202	261852	H-40 Cylinder Seal Kit	Pump
202	247581	H-30 and H-50 Cylinder Seal Kit	Pump
202	261847	H-XP2 and H-XP3 Piston Seal Kit	Pump
202	261845	H-40 Piston Seal Kit	Pump
202	247579	H-30 and H-50 Piston Seal Kit	Pump
906, 907	24V020	Y-Strainer Filter and Gasket Kit (pack of two each)	Y-Strainer
402	247824	Drain Valve Cartridge	Fluid Manifold
403	102814	Fluid Pressure Gauge	Fluid Manifold
405	15M669	Pressure Sensor	Fluid Manifold
511, 512	24L973	RTD Repair Kit	Heater
--	24K207	Hose FTS	Hose
--	24N450	RTD Cable (50 ft. replacement)	Hose
--	24N365	RTD Cable Test Kit (To assist measuring RTDs and RTD cable resistances)	Hose

Technical Specifications

Reactor 2 Hydraulic Proportioning System		
	U.S.	Metric
Maximum Fluid Working Pressure for Bare Proportioners		
Models H-30, H-40, and H-50	2000 psi	13.8 MPa, 138 bar
Models H-XP2 and H-XP3	3500 psi	24.1 MPa, 241 bar
Minimum Fluid Working Pressure for Bare Proportioners		
H-30	700 psi	4.8 MPa, 48 bar
H-40, H-50	600 psi	4.1 MPa, 41 bar
H-XP2	1200 psi	8.2 MPa, 82 bar
H-XP3	850 psi	5.8 MPa, 58 bar
Fluid: Oil Pressure Ratio		
Model H-40	1.91 : 1	
Models H-30 and H-50	1.64 : 1	
Models H-XP2 and H-XP3	2.79 : 1	
Fluid Inlets		
Component A (ISO)	3/4 npt(f), 300 psi maximum	3/4 npt(f), 2.07 MPa, 20.7 bar maximum
Component B (RES)	3/4 npt(f), 300 psi maximum	3/4 npt(f), 2.07 MPa, 20.7 bar maximum
Fluid Outlets		
Component A (ISO)	#8 1/2 in. JIC, with #5 5/16 in. JIC adapter	
Component B (RES)	#10 5/8 in. JIC, with #6 3/8 in. JIC adapter	
Fluid Circulation Ports		
1/4 npsm(m)	250 psi	1.75 MPa, 17.5 bar
Maximum Fluid Temperature		
	190° F	88° C
Maximum Output (10 weight oil at ambient temperature)		
Model H-30	28 lb/min (60 Hz)	13 kg/min (60 Hz)
Model H-XP2	1.5 gpm (60 Hz)	5.7 liter/min (60 Hz)
Model H-50	52 lb/min (60 Hz)	24 kg/min (60 Hz)
Model H-40	45 lb/min (60 Hz)	20 kg/min (60 Hz)
Model H-XP3	2.8 gpm (60 Hz)	10.6 liter/min (60 Hz)
Output Per Cycle (A and B)		
Model H-40	0.063 gal.	0.24 liter
Models H-30 and H-50	0.074 gal.	0.28 liter
Models H-XP2 and H-XP3	0.042 gal.	0.16 liter

Supply Voltage Tolerance		
200–240V nominal, 1 phase (H-30, H-XP2 only)	195–264 VAC, 50/60 Hz	
200–240V nominal, 3 phase	195–264 VAC, 50/60 Hz	
350–415V nominal, 3 phase	338–457 VAC, 50/60 Hz	
Amperage Requirement (phase)		
See the Models listing in the manual.		
Heater Power (A and B heaters total)		
See the Models listing in the manual.		
Hydraulic Reservoir Capacity		
	3.5 gal.	13.6 liters
Recommended Hydraulic Fluid		
	Citgo, A/W Hydraulic Oil, ISO Grade 46	
Sound Power, per ISO 9614–2		
	90.2 dB(A)	
Sound Pressure 1 m From Equipment		
	82.6 dB(A)	
Weight		
H-40, H-50, H-XP3,	600 lb	272 kg
H-30, 10 kW	544 lb	247 kg
H-30, H-XP2, 15 kW	556 lb	252 kg
Wetted Parts		
	Aluminum, stainless steel, zinc-plated carbon steel, brass, carbide, chrome, fluoroelastomer, PTFE, ultra-high molecular weight polyethylene, chemically resistant o-rings	
<i>All other brand names or marks are used for identification purposes and are trademarks of their respective owners.</i>		

California Proposition 65

CALIFORNIA RESIDENTS

 **WARNING:** Cancer and reproductive harm — www.P65warnings.ca.gov.

Graco Extended Warranty

Graco warrants all equipment referenced in this document which is manufactured by Graco and bearing its name to be free from defects in material and workmanship on the date of sale to the original purchaser for use. Graco will, for a period as defined in the table below from the date of sale, repair or replace any part of the equipment determined by Graco to be defective. This warranty applies only when the equipment is installed, operated and maintained in accordance with Graco's written recommendations.

Part	Description	Warranty Period
24U854	Advanced Display Module	36 Months or 2 Million Cycles (whichever comes first)
24Y263	Hydraulic Control Module	36 Months or 2 Million Cycles (whichever comes first)
24U855	Temperature Control Module	36 Months or 2 Million Cycles (whichever comes first)
All Other Parts		12 Months

This warranty does not cover, and Graco shall not be liable for general wear and tear, or any malfunction, damage or wear caused by faulty installation, misapplication, abrasion, corrosion, inadequate or improper maintenance, negligence, accident, tampering, or substitution of non-Graco component parts. Nor shall Graco be liable for malfunction, damage or wear caused by the incompatibility of Graco equipment with structures, accessories, equipment or materials not supplied by Graco, or the improper design, manufacture, installation, operation or maintenance of structures, accessories, equipment or materials not supplied by Graco.

This warranty is conditioned upon the prepaid return of the equipment claimed to be defective to an authorized Graco distributor for verification of the claimed defect. If the claimed defect is verified, Graco will repair or replace free of charge any defective parts. The equipment will be returned to the original purchaser transportation prepaid. If inspection of the equipment does not disclose any defect in material or workmanship, repairs will be made at a reasonable charge, which charges may include the costs of parts, labor, and transportation.

THIS WARRANTY IS EXCLUSIVE, AND IS IN LIEU OF ANY OTHER WARRANTIES, EXPRESS OR IMPLIED, INCLUDING BUT NOT LIMITED TO WARRANTY OF MERCHANTABILITY OR WARRANTY OF FITNESS FOR A PARTICULAR PURPOSE.

Graco's sole obligation and buyer's sole remedy for any breach of warranty shall be as set forth above. The buyer agrees that no other remedy (including, but not limited to, incidental or consequential damages for lost profits, lost sales, injury to person or property, or any other incidental or consequential loss) shall be available. Any action for breach of warranty must be brought within two (2) years of the date of sale.

GRACO MAKES NO WARRANTY, AND DISCLAIMS ALL IMPLIED WARRANTIES OF MERCHANTABILITY AND FITNESS FOR A PARTICULAR PURPOSE, IN CONNECTION WITH ACCESSORIES, EQUIPMENT, MATERIALS OR COMPONENTS SOLD BUT NOT MANUFACTURED BY GRACO.

These items sold, but not manufactured by Graco (such as electric motors, switches, hose, etc.), are subject to the warranty, if any, of their manufacturer. Graco will provide purchaser with reasonable assistance in making any claim for breach of these warranties.

In no event will Graco be liable for indirect, incidental, special or consequential damages resulting from Graco supplying equipment hereunder, or the furnishing, performance, or use of any products or other goods sold hereto, whether due to a breach of contract, breach of warranty, the negligence of Graco, or otherwise.

FOR GRACO CANADA CUSTOMERS

The Parties acknowledge that they have required that the present document, as well as all documents, notices and legal proceedings entered into, given or instituted pursuant hereto or relating directly or indirectly hereto, be drawn up in English. Les parties reconnaissent avoir convenu que la rédaction du présente document sera en Anglais, ainsi que tous documents, avis et procédures judiciaires exécutés, donnés ou intentés, à la suite de ou en rapport, directement ou indirectement, avec les procédures concernées.

Graco Information

For the latest information about Graco products, visit www.graco.com.

For patent information, see www.graco.com/patents.

To place an order, contact your Graco Distributor or call to identify the nearest distributor.

Phone: 612-623-6921 **or Toll Free:** 1-800-328-0211 **Fax:** 612-378-3505

All written and visual data contained in this document reflects the latest product information available at the time of publication.

Graco reserves the right to make changes at any time without notice.

Original Instructions. This manual contains English. MM **334946**

Graco Headquarters: Minneapolis

International Offices: Belgium, China, Japan, Korea

GRACO INC. AND SUBSIDIARIES • P.O. BOX 1441 • MINNEAPOLIS MN 55440-1441 • USA

Copyright 2020, Graco Inc. All Graco manufacturing locations are registered to ISO 9001.

www.graco.com

Revision H, April 2020