

Contractor & FTx Spray Guns

Contractor Models: 288420, 288421, 288425, 288475, 288477, 288478, 826085, 288009, 262114
 FTx Models: 288427, 288428, 288429, 288430, 288431, 288436, 288438, 288477, 288478, 826086,
 288008, 262116, 17C926

311861J
 EN

For the application of architectural paints and coatings.

Maximum Working Pressure: 3600 psi (248 bar, 24.8 MPa)



IMPORTANT SAFETY INSTRUCTIONS. Read all warnings and instructions in this manual. Refer to your sprayer instruction manual for Pressure Relief, priming and spray instructions. Save all instructions.

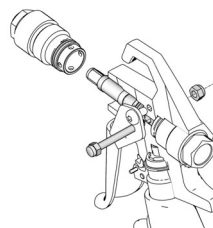

ti8501b

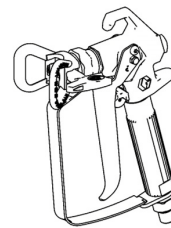

ti8522b

The following warnings are for the setup, use, grounding, maintenance, and repair of this equipment. The exclamation point symbol alerts you to a general warning and the hazard symbol refers to procedure-specific risk. Refer back to these warnings. Additional, product-specific warnings may be found throughout the body of this manual where applicable.

WARNING



SKIN INJECTION HAZARD

High-pressure fluid from gun, hose leaks, or ruptured components will pierce skin. This may look like just a cut, but it is a serious injury that can result in amputation. **Get immediate surgical treatment.**

- Do not point gun at anyone or at any part of the body.
- Do not put your hand over the spray tip.
- Do not stop or deflect leaks with your hand, body, glove, or rag.
- Do not spray without tip guard and trigger guard installed.
- Engage trigger lock when not spraying.
- Follow **Pressure Relief Procedure** in this manual, when you stop spraying and before cleaning, checking, or servicing equipment.



FIRE AND EXPLOSION HAZARD

Flammable fumes, such as solvent and paint fumes, in **work area** can ignite or explode. To help prevent fire and explosion:

- Use equipment only in well ventilated area.
- Eliminate all ignition sources; such as pilot lights, cigarettes, portable electric lamps, and plastic drop cloths (potential static arc).
- Keep work area free of debris, including solvent, rags and gasoline.
- Do not plug or unplug power cords, or turn power or light switches on or off when flammable fumes are present.
- Ground all equipment in the work area. See **Grounding** instructions.
- Use only grounded hoses.
- Hold gun firmly to side of grounded pail when triggering into pail.
- If there is static sparking or you feel a shock, **stop operation immediately.** Do not use equipment until you identify and correct the problem.
- Keep a working fire extinguisher in the work area.



PRESSURIZED ALUMINUM PARTS HAZARD

Use of fluids that are incompatible with aluminum in pressurized equipment can cause a serious chemical reaction and equipment rupture. Failure to follow this warning may result in death, serious injury, or property damage.

- Do not use 1,1,1-trichloroethane, methylene chloride, other halogenated hydrocarbon solvents or fluids containing such solvents.
- Many other fluids may contain materials that are incompatible with aluminum. Contact your material supplier for verification.

⚠ WARNING



EQUIPMENT MISUSE HAZARD

Misuse can cause death or serious injury.

- Do not operate the unit when fatigued or under the influence of drugs or alcohol.
- Do not exceed the maximum working pressure or temperature rating of the lowest rated system component. See **Technical Data** in all equipment manuals.
- Use fluids and solvents that are compatible with equipment wetted parts. See **Technical Data** in all equipment manuals. Read fluid and solvent manufacturer's warnings. For complete information about your material, request MSDS forms from distributor or retailer.
- Check equipment daily. Repair or replace worn or damaged parts immediately with genuine manufacturer's replacement parts only.
- Do not alter or modify equipment.
- Use equipment only for its intended purpose. Call your distributor for information.
- Route hoses and cables away from traffic areas, sharp edges, moving parts, and hot surfaces.
- Do not kink or over bend hoses or use hoses to pull equipment.
- Keep children and animals away from work area.
- Comply with all applicable safety regulations.



PERSONAL PROTECTIVE EQUIPMENT

You must wear appropriate protective equipment when operating, servicing, or in the operating area of the equipment to help protect you from serious injury. This equipment includes but is not limited to:

- Protective eyewear, gloves, hearing protection
- Clothing and respirator as recommended by the fluid and solvent manufacturer

Pressure Relief Procedure

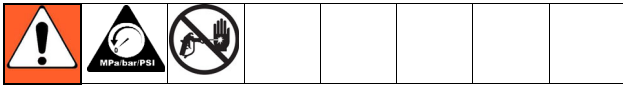

Follow this **Pressure Relief Procedure** whenever instructed to relieve pressure, stop spraying, check or service equipment, or install or clean spray tip.

1. Turn OFF power and turn sprayer pressure control to lowest pressure setting.
2. Hold gun against side of flushing pail. Trigger gun into pail to relieve pressure.

If you suspect spray tip or hose is clogged or that pressure has not been fully relieved after following the steps above, **VERY SLOWLY** loosen tip guard retaining nut or hose end coupling to relieve pressure gradually, then loosen completely. Clear hose or tip obstruction.

Gun Trigger Lock (2)

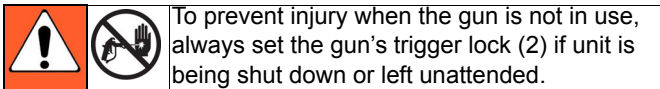

To prevent injury when the gun is not in use, always set the gun's trigger lock (2) if unit is being shut down or left unattended.

Trigger Locked
(no spray)

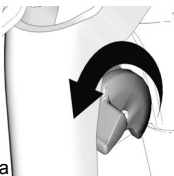

ti10166a

Trigger
Unlocked
(spray)

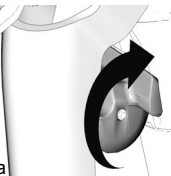

ti10167a

Setup

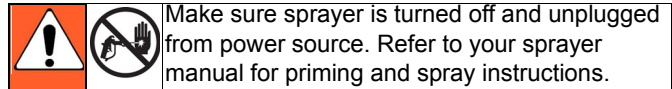

Make sure sprayer is turned off and unplugged from power source. Refer to your sprayer manual for priming and spray instructions.

Connect Gun to Sprayer

1. Attach supply hose to sprayer fluid outlet.
2. Attach other end of supply hose to gun swivel (8). Use two wrenches (one on the swivel (8) and one on the hose), to tighten all connections securely.
3. Refer to sprayer instruction manual for priming instructions.

Installing Tip (26) and Guard (25) on Gun

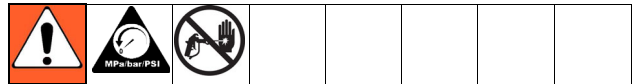

1. If equipment has recently been operated, **relieve pressure**. Set trigger lock (2).
2. Using a pencil or similar object, insert seal (24) into back of guard (25).
3. Install guard (25) over end of gun (1).
4. Insert tip (26) in guard (25). Tighten retaining nut.

Operation

Spraying

1. Unlock trigger lock (2).
2. Be sure the arrow shaped tip (26) faces forward (spray).
3. Hold gun perpendicular and approximately 12-inches (304 mm) from surface. Move gun first, then pull gun trigger (13) to spray a test pattern.
4. Slowly increase pump pressure until coverage is uniform and even (see sprayer instruction manual for additional information).

Aligning Spray

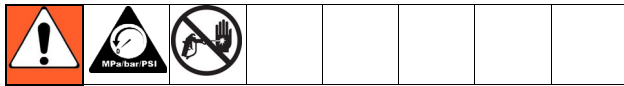

1. **Relieve pressure.** Set trigger lock (2). Loosen guard retaining nut.
2. Loosen guard retaining nut.
3. Align guard (25) horizontally to spray a horizontal pattern.
4. Align guard (25) vertically to spray a vertical pattern.

(3) Horizontal

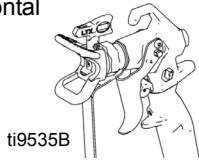

(4) Vertical

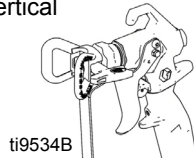

Parts

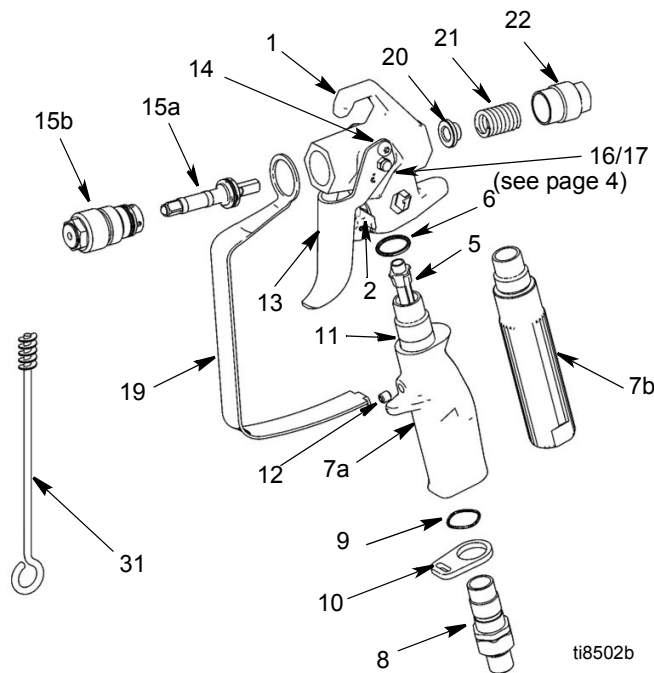

Clearing Clogs

Parts

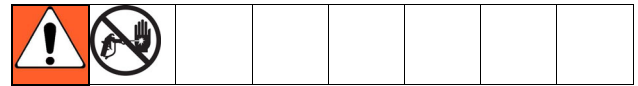

1. **Relieve pressure.** Set trigger lock (2).
2. Rotate tip (26) 180°. Unlock trigger lock (2). Trigger gun into pail or onto ground to remove clog.
3. Set trigger lock (2). Rotate tip (26) 180° back to spray position.

Cleanup

Flush gun after each work shift and store in a dry location. Do not leave the gun or any parts in water or cleaning solvents.

Ref.	Part	Description	Qty
1	288812	HOUSING, assy., Contractor	1
	289914	HOUSING, assy., FTX	1
5	287032	FILTER, 60 mesh	1
	287033	FILTER, 100 mesh	1
	287034	FILTER, 60 and 100 mesh combo	1
6	120777	PACKING, o-ring	1
7		HANDLE	1
7a	15K282	Contractor Gun	1
7b	15J735	FTX Gun	1
	15J736	FTX-A Gun (not shown)	1
8	288811	SWIVEL, assy, gun	1
9	120733	O-RING, urethane, clear	1
10	15J706	RETAINER, guard, trigger	1
11	15J698	TUBE, handle, Contractor Gun	1
12	120834	SCREW, set, Contractor Gun	1
13	15J409	TRIGGER, Contractor/FTX Gun, 2-finger	1
	15J768	TRIGGER, Contractor Gun, 4-finger (not shown)	1
	15J769	TRIGGER, FTX Gun, 4-finger (not shown)	1
14	117602	SCREW, shoulder, pan hd	2
15	288488	KIT, needle, repair	1
15a		NEEDLE, assembly	1
15b		DIFFUSER, assembly	1
16	15J696	PIN, trigger (page 4)	1
17	105334	NUT, lock, hex (page 4)	1
19	15J464	GUARD, trigger	1
20	15J528	GUIDE, spring	1
21	121093	SPRING, compression	1
22	15B549	NUT, end	1
31	119799	BRUSH, cleaning	1

Tip and Guard

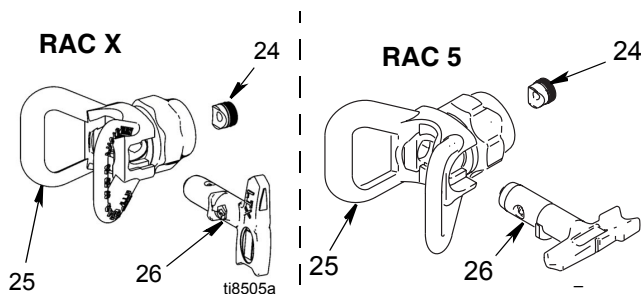

Ref.	Part	Description	Qty
24	246453	OneSeal™, RAC X (5-pack)	1
	243281	OneSeal™, RAC 5 (5-pack)	1
25	246215	GUARD, RAC X	1
	243161	GUARD, RAC 5	1
26	LTX515	TIP, spray 515, RAC X	1
	LTX517	TIP, spray 517, RAC X	1
	286515	TIP, spray 515, RAC 5	1
	286517	TIP, 517, RAC 5	1
	PAA517	TIP, spray, latex, RAC X (517), Europe	1
	PAA515	TIP, spray, latex, RAC X (515), Europe	1
	262517	TIP, spray, 517, RAC 5, Europe	1

Maintenance

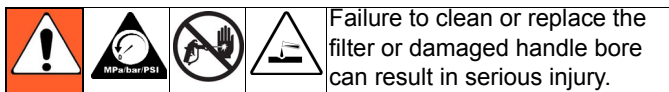

Before performing any maintenance on gun, read all warnings on front cover of this manual and **relieve pressure**.

Cleaning/Replacing Filter (5)

A plugged filter reduces gun performance. Clean filter after each use.

1. **Relieve pressure.** Set trigger lock (2).
2. Disconnect fluid hose from gun at swivel (8).
3. Disconnect trigger guard (19) from guard retainer (10).
4. Unscrew handle (7) from gun (1).
5. Remove filter (5) through top of handle (7).
6. Inspect filter (5) for damage to the filter mesh. Replace the filter if the filter mesh has holes or voids.
7. Clean filter (5). Use a soft brush to loosen and remove excess debris.
8. Inspect handle bore (7) for damage. Replace the handle bore if it is corroded or pitted and check material for compatibility with aluminum.
9. Insert clean filter (5) into handle (7).
10. Reattach handle (7) to gun (1). Tighten securely.
11. Reconnect trigger guard (19) to guard retainer (10).

Repair

Tools needed:

- 8-inch adjustable wrench
- 1/4-inch nut driver

Replacing Needle

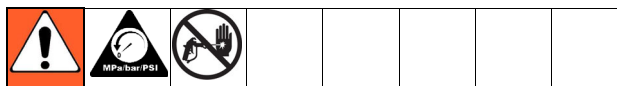
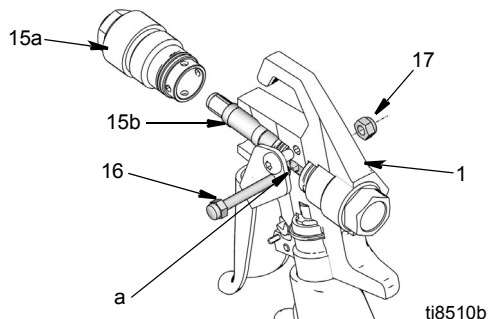

1. **Relieve pressure.** Set trigger lock (2).
2. Remove tip (26) and guard (25) from gun (1).
3. Disconnect fluid hose from gun at swivel (8).
4. Remove nut (17) and trigger pin (16).
5. Unscrew diffuser (15a) from front of gun (1).
6. Remove needle assembly (15b) through front of gun (1).
7. Use a soft brush to clean out internal passages of gun.
8. Grease o-rings of new needle using a non-silicon grease.
9. Guide new needle (15b) through front of gun (1) making sure the flat sides (a) of the needle assembly face the sides of gun housing.
10. Install diffuser (15a). Torque diffuser to 26-30 ft-lbs (35.25 - 43.38 N•m).
11. Replace pin (16) and nut (17).

Translated Manuals

Spanish - 312098	Estonian - 312277
French - 312099	Latvian - 312278
Dutch - 312265	Lithuanian - 312279
German - 312266	Polish - 312280
Italian - 312267	Hungarian - 312281
Turkish - 312268	Czech - 312282
Greek - 312269	Slovakian - 312283
Croatian - 312270	Slovenian - 312284
Portuguese - 312271	Romanian - 312285
Danish - 312272	Bulgarian - 312286
Finnish - 312273	Chinese - 312287
Swedish - 312274	Japanese - 312288
Norwegian - 312275	Korean - 312289
Russian - 312276	

Translated manuals can be requested through a distributor or at www.graco.com.

Technical Data

Maximum working pressure	3600 psi (248 bar, 24.8 MPa)
Fluid orifice size	0.125 in. (3.18 mm)
Weight (with tip and guard)	22 oz. (630 g)
Inlet	1/4 npsm swivel
Maximum material temperature	120°F (49°C)
Wetted parts	Stainless steel, polyurethane, nylon, aluminum, tungsten carbide, solvent resistant elastomer, brass
Noise Level*	
Sound power	87 dBa
Sound pressure	78 dBa

*Measured at 3.1 feet (1m) while spraying water-based paint, specific gravity 1.36, through a 517 tip at 3000 psi (207 bar, 20.7 MPa) per ISO 3744

For complete warranty information contact your Graco distributor, call Graco customer service: 1-800-690-2894 or visit our website: www.graco.com

All written and visual data contained in this document reflects the latest product information available at the time of publication. Graco reserves the right to make changes at any time without notice.

For patent information, see www.graco.com/patents.

Original instructions. This manual contains English. MM 311861

Graco Headquarters: Minneapolis

International Offices: Belgium, China, Japan, Korea

GRACO INC. AND SUBSIDIARIES • P.O. BOX 1441 • MINNEAPOLIS MN 55440-1441 • USA
Copyright 2007, Graco Inc. All Graco manufacturing locations are registered to ISO 9001.

www.graco.com

Revised November 2014